

PERSONALSCOPE™

User Manual for HPS10 - HPS40

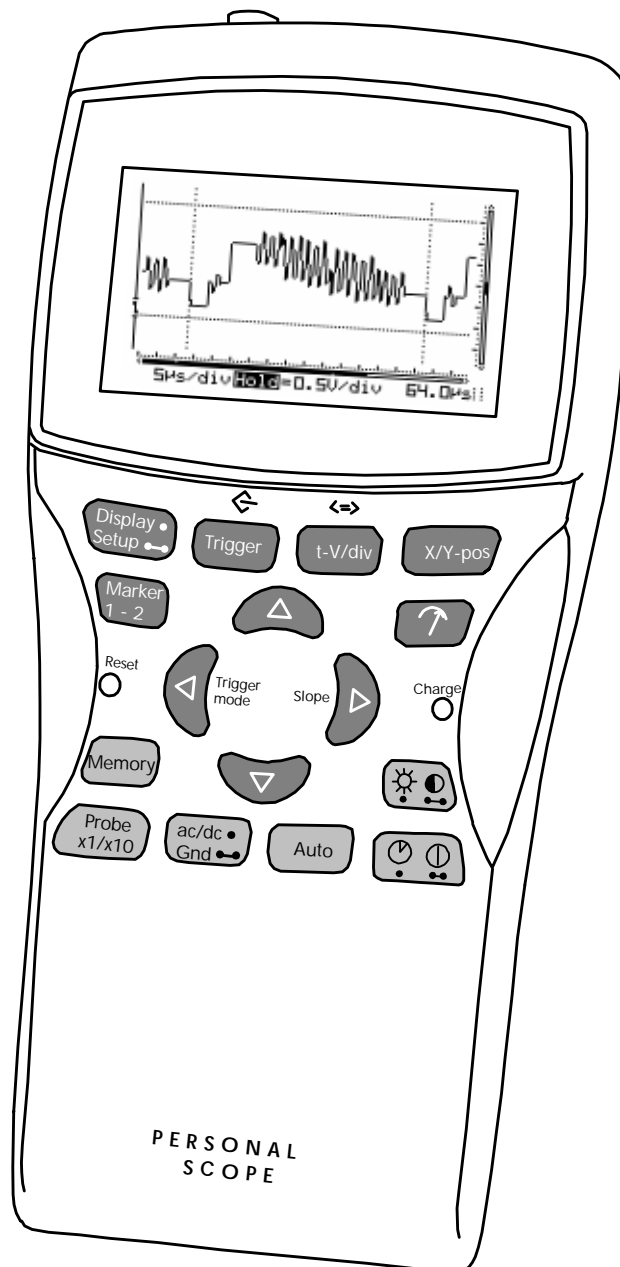

**Velleman Components
Legen Heirweg 33
9890 Gavere
Belgium
Internet Site: <http://www.velleman.be>**

HHPS40/10 – UK - 2002

FCC information for the USA

This equipment has been tested and found to comply with the limits for a Class B digital device, pursuant to Part 15 of the FCC Rules. These limits are designed to provide reasonable protection against harmful interference in a residential installation. This equipment generates, uses and can radiate radio frequency energy and, if not installed and used in accordance with the instructions, may cause harmful interference to radio communications. However, there is no guarantee that interference will not occur in a particular installation. If this equipment does cause harmful interference to radio or television reception, which can be determined by turning the equipment off and on, the user is encouraged to try to correct the interference by one or more of the following measures:

- Reorient or relocate the receiving antenna.
- Increase the separation between the equipment and receiver.
- Connect the equipment into an outlet on a circuit different from that to which the receiver is connected.
- Consult the dealer or an experienced radio/TV technician for help.

IMPORTANT

This equipment was tested for FCC compliance under conditions that include the use of shielded test leads between it and the peripherals. It is important that you use shielded cables and connectors to reduce the possibility of causing Radio and Television interference. Only use the supplied cables.

If the user modifies the HPS40 (HPS10) oscilloscope or its connections in any way, and these modifications are not approved by Velleman, the FCC may withdraw the user's right to operate the equipment.

The following booklet prepared by the Federal Communications Commission may be of help: "How to identify and Resolve Radio-TV Interference problems". This booklet is available from the US Government Printing Office, Washington, DC20402 Stock No. 044-000-00345-4.

UNIT INFORMATION:

OWNER NAME:

DATE OF PURCHASE:

UNIT PART NUMBER:

DESCRIPTION:

UNIT SERIAL NUMBER:

UNIT SOFTWARE BUILD VERSION:

CONTENTS

FCC information for the USA	3
Important.....	3
General	6
Features.....	6
Options	6
Safety and warnings	7
Power supply.....	8
Use	9
Survey of the connections and controls	9
Survey of the indications on the screen.....	9
Operation	10
Turning on/off the Personal Scope.....	10
Adjusting the contrast.....	10
Display setup.....	10
Setup menu.....	11
Readout setup.....	13
Probe setup.....	15
The signal Markers.....	16
Signal Screen.....	16
Choice of input coupling.....	17
Set the input reference.....	17
Auto-Setup function.....	17
Changing the input sensitivity and time base	18
Trigger setup.....	19
Holding the screen	21
Store a screen.....	21
Recall memories	21
Sending a screen capture to the computer (Only for HPS40).....	22
Resetting the personal scope	23
Troubleshooting.....	24
Warranty	25
Maintenance	26
Technical specifications.....	27
HPS40.....	27
HPS10.....	28

GENERAL

FEATURES

- High contrast LCD.
- With backlight (**Only for HPS40**).
- Full auto set up for volt/div and time/div.
- Recorder roll mode, up to 25h per screen.
- Trigger mode: run - normal - once - roll, slope -/+
- Adjustable trigger level (**Only for HPS40**)
- Peak measurements: Max, min. and peak to peak.
- AC measurements: rms, dB(relat.), dBV and dBm.
- AC+DC measurements: DC, rms, dB, dBV and dBm.
- Audio power measurements into 2, 4, 8, 16 and 32ohm: Rms Power, peak power and ac+dc power.
- x1 and x10 probe calculation option.
- Several display modes.
- X and Y position shift.
- Marker readout: dt - 1/dt (frequency) - dV.
- AC/DC input coupling selection.
- Zero reference set for DC and dB.
- 2 Memories with compare function.
- Auto power off or continuous on.
- Low battery detection.

OPTIONS

Adapter: type PS905 for 230V / PS905USA for 110V (Fig 1.0).

Includes for HPS40:

- BagHPS
- CaseHPS

SAFETY AND WARNINGS



- The PersonalScope is ideally suited for measurements of category II installations with pollution degree 1 and using a maximum of 600V, in accordance with the IEC1010-1 norm. The enclosure is UL 94V0 listed
- Consequently, all measurements should be avoided in case of polluted or very humid air. One should also refrain from measuring conductors or installations that use voltages that exceed 600Vrms above ground level. CAT II indicates conformity for measurements of domestic installations.
- The maximum input voltage for the connections of the unit stands at 100Vp (AC+DC)
- Do NOT open the enclosure while performing measurements.
- Remove all test leads before opening the enclosure in order to avoid electrical shock.
- Use a measuring probe with an insulated connector when measuring voltages exceeding 30V. (PROBE60S).
- Remove the batteries in case of a prolonged period of inactivity.

Remove all non-rechargeable batteries when connecting an AC/DC adapter !

Do NOT perform measurements unless the battery compartment is closed. The battery cover should only be removed for the calibration of the probe's X10-position.

When first using the rechargeable batteries or if the batteries are completely discharged, the user should charge them for at least 12 hours before using the unit. When the unit is OFF, the charging time for 800mA/h type batteries will be approx. 12 hours. The "Charge" indication LED on the front panel will light up when the batteries are being charged. (see fig.2.0)

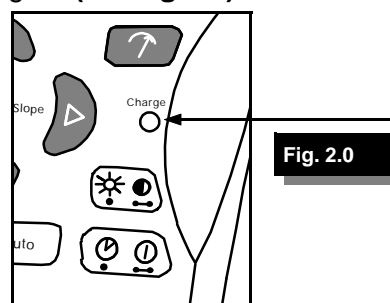

Fig. 2.0

The message "Low bat." will flash in the bottom right corner of your display when the batteries need replacement (or charging). Insufficient battery voltage may entail erroneous measuring results. (See fig.3.0)

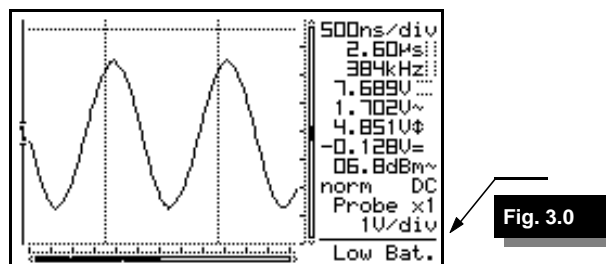

Fig. 3.0

POWER SUPPLY

The HPS40 (HPS10) PersonalScope can be powered by means of an adapter, ordinary batteries or rechargeable ones. Rechargeable batteries are advised for intensive use. The higher the capacity of the rechargeable batteries, the longer the autonomy of the unit.

Attention:

Use a non-regulated adapter of 9VDC that supplies a min. of 300mA. Observe the polarity and consult your retailer if necessary. **(Fig. 5.0)**

When using a regulated adapter, the user should verify whether it can supply 12VDC.

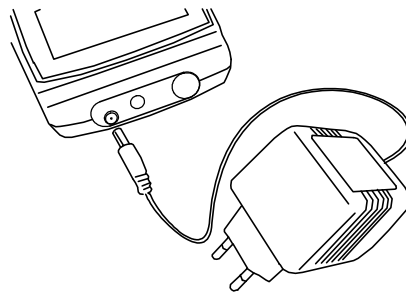

Fig 5.0

Batteries (option):

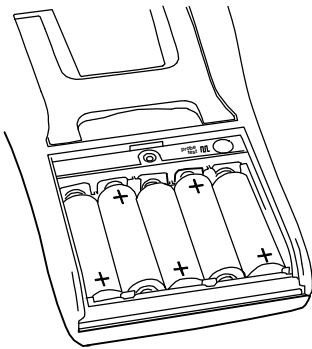

Fig 4.0

The unit can be used with either ordinary alkaline batteries or rechargeable type (5x). **(Fig. 4.0)**

Open the battery cover by loosening the screw.

Insert the batteries in the holders. Mind the polarity!
Remove all non-rechargeable batteries when connecting an AC/DC adapter!

USE

Survey of the connections and controls

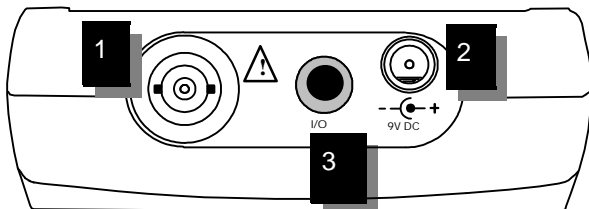

Fig 6.0

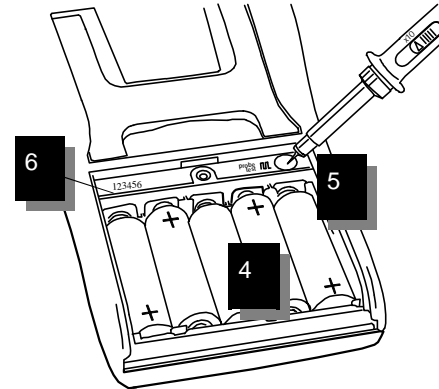
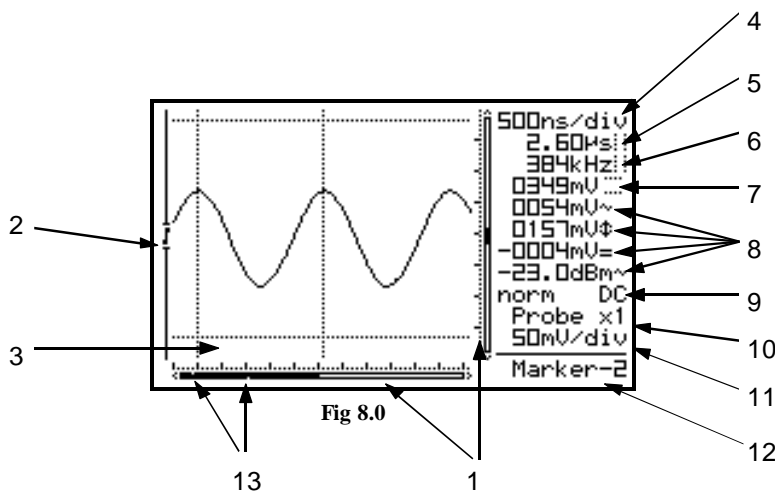

Fig 7.0

1. BNC input connector (max. input 100Vp AC+DC).
2. Adapter connection (observe the polarity!)
3. RS232 output connector (optical isolated). Use the supplied RS232 cable, settings are: 57600 Baud, 8 data bits, no parity, 1 stop bit, no handshake. (**Only for HPS40**)
4. Battery compartment.
5. X10 probe testing signal behind battery cover.
6. Serial number.

Survey of the indications on the screen:



1. Relative position indication of the signal in the window. (**Not for HPS10**)
2. Trigger position and slope indication.
3. Signal window with (possibly) the markers or grid to indicate the various divisions.
4. Time per division.
5. Time between markers (if present).
6. Calculated frequency $1/dt$ between markers (if present).
7. Voltage between the markers (if present).

8. Measurement readout. Depending on screen layout. See page 10.
9. Trigger information or screen hold indication, input-coupling indication.
10. X1 or X10 probe setup indication.
11. Selected voltage per division.
12. Indication of the selected cursor key function or battery-low indication.
13. Small dots indicating relative marker position (only if markers are present). (**Not for HPS10**)

OPERATION

NOTE:

- If functions are used together with cursor keys a short indication will pop up at the right bottom of the screen.
- Some keys have double function selected with a long --- or short • press.
- In most selections, the unit will return to the default t-V/div mode if no key is pressed during 10 sec, a selection will be cancelled.

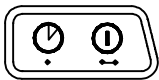

POWER ON/OFF

Short press: On (Off) with auto power off timer.

Long press: On without auto power off timer.

Note:

- Pressing a key resets the auto power off timer.
- The power-off mode is displayed at the bottom of the screen during start-up.
- All scope settings are retained after power off.
- If 'HOLD'-mode was selected prior to pressing the 'power on/off'-key, the displayed waveform will be retained.

Just for HPS40 :

- After power on, the unit will send the current data through the RS232 port:
 - 1- Settings and samples stored in memory.
 - 2- Settings and samples of the screen.

Use a standard terminal program or download software from our web site.



ADJUSTING THE CONTRAST

Short press: Backlight on/off. (*Only for HPS40*)

Short press: Maximum contrast (*Only for HPS10*)

Long press: Change the contrast.

Keep pressing the 'Contrast'-key to change the contrast. Release the button at the desired setting.



DISPLAY SET-UP

Short press: Use the left/right cursorkeys to select one of the 5 screen layouts. (See fig.9 to 13)

Use the up/down cursorkeys to view/hide the markers or grid on the screen.

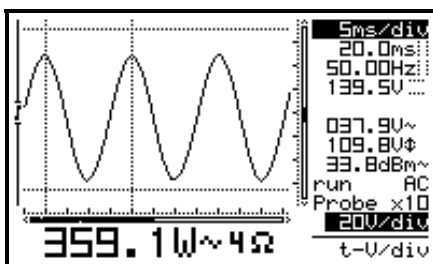

Fig 9

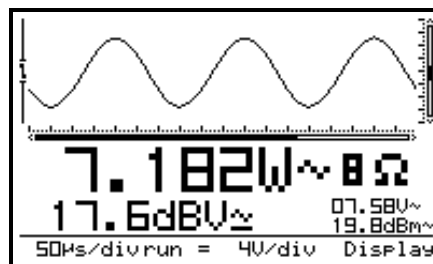

Fig 10

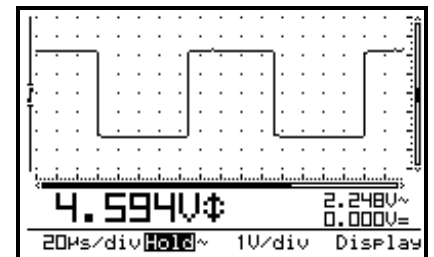

Fig 11

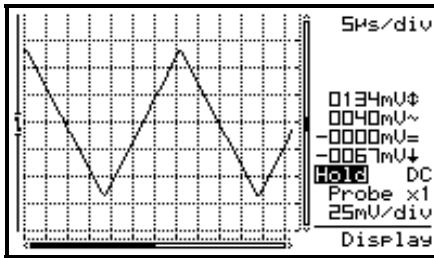

Fig 12

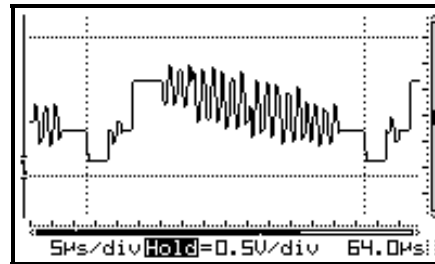

Fig 13

- A **dot grid** divides the screen into reference points. (Fig. 11)
- A **full grid** divides the screen into reference lines.(Fig. 12)
- **Markers:** Moveable markers in order to measure the signal (Fig. 13).
- A **cross** inserts a coordinate system into the screen. (**Just for HPS10**)

 **Notes:**

- The number of readout-digits depends on the selected display layout.
- At **dynamic** display mode (see display setup), the display layout changes for best fitting by shifting the markers or x-position.
- When no markers are displayed, the cursor keys are set for changing the time base or input sensitivity when no keys are pressed during 10 seconds.
- Markers can also be accessed directly by pressing the '**Marker 1-2**' key.



SETUP MENU

Long press: Shows a setup menu for changing the operation mode, the default power-off timer, the display mode (and RS232 transmit setup → **Only for HPS40**).

1. Select the highlighted item with a short keypress of the setup-key and the cursor keys.
2. Keep the setup-key pressed to exit the setup-menu and to apply the selections.

 **Note:**

- A Checkmark indicates the current selection.
- Leaving the mode menu with the '**power off**' key will cancel the selection.
- If no key is pressed during 10 seconds, the selection will be cancelled; the unit returns to it previous operating mode and the cursor keys are set for changing the time base or input sensitivity.

1. Operating mode

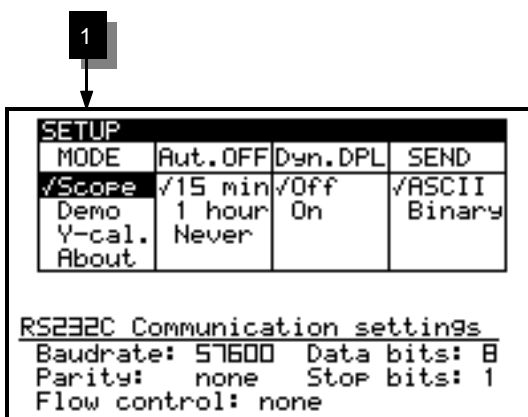

Fig 14

Scope: normal operation mode

Demo: Scope goes into demo mode; several animated screens are displayed one after the other.

Y-cal.: To calibrate the centre of the signal; Use this only if the Y position is incorrect during Auto set-up mode. (**Just for HPS40**)

About: Version information of the scope software is displayed

 **Note:**

- Hiding the version screen can only be done by long keypressing of the '**Setup**'-key and choosing a different operation mode.
- Most of the keyboard functions are disabled.

2. Auto power-off mode

2

SETUP			
MODE	Aut. OFF	Dyn. DPL	SEND
/Scope	/15 min	/Off	/ASCII
Demo	1 hour	On	Binary
Y-cal.	Never		
About			

RS232C Communication settings
 Baudrate: 57600 Data bits: 8
 Parity: none Stop bits: 1
 Flow control: none

Fig 15

Select the desired off time: 15 minutes, 1 hour or infinite (no auto power off).

Notes:

- Before power-off, the scope holds the last screen.
- The auto power-off timer is factory-set to 15min at first power-on or after a reset
- Selecting a slow time base (equal or slower than 1min/div) will disable the auto power off.
- If „Never“ is selected the backlight will remain always on if activated. (**Only for HPS40**).

3. Display mode

3

SETUP			
MODE	Aut. OFF	Dyn. DPL	SEND
/Scope	/15 min	/Off	/ASCII
Demo	1 hour	On	Binary
Y-cal.	Never		
About			

RS232C Communication settings
 Baudrate: 57600 Data bits: 8
 Parity: none Stop bits: 1
 Flow control: none

Fig 15

Dynamic: The screen layout changes automatically to show the best signal resolution, depending on X position shift and the position of the markers. See also “using the markers”
Manual: The screen layout remains fixed according to your selection.

4. RS232 send mode. (Only for HPS40)

4

SETUP			
MODE	Aut. OFF	Dyn. DPL	SEND
/Scope	/15 min	/Off	/ASCII
Demo	1 hour	On	Binary
Y-cal.	Never		
About			

RS232C Communication settings
 Baudrate: 57600 Data bits: 8
 Parity: none Stop bits: 1
 Flow control: none

Fig 15

ASCII: a file with settings and samples (relative value 0 to 255) is send after power on or during roll mode. This setting is normally used in conjunction with a terminal program.
Binary: As above, but data are output in a binary form. Use this setting with special software, check our web site.



READOUT SET-UP

Press to call the meter 1 to 4 selection menu. Make use of the cursorkeys to set readout for up to 4 meters

Setting up the measurement readouts:

1. Pressing the 'meter'-key selects the first readout location. (Fig. 17)
2. Press the cursorkeys to highlight the desired readout function for meter1 readout. (Fig. 17)
3. Pressing the 'meter'-key selects the second readout location (Fig. 18)
4. Press the cursorkeys to highlight the desired readout function for meter2 readout. (Fig. 18)
5. Pressing the 'meter'-key selects the third readout location (Fig. 19)
6. Press the cursorkeys to highlight the desired readout function for meter3 readout. (Fig. 19)
7. Pressing the 'meter'-key selects the fourth readout location. (Fig. 20)
8. Press the cursorkeys to highlight the desired readout function for meter4 readout. (Fig. 20)
9. Pressing the 'meter'-key returns to scope mode.

The Personal Scope offers many measuring possibilities.

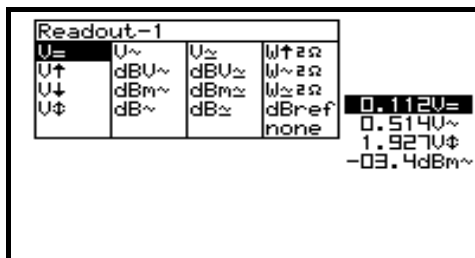

Fig 17

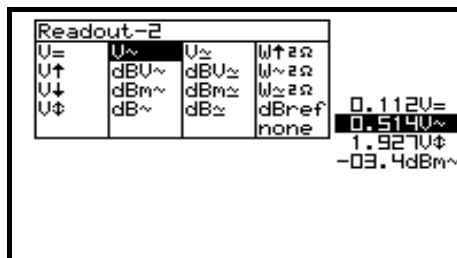

Fig 18

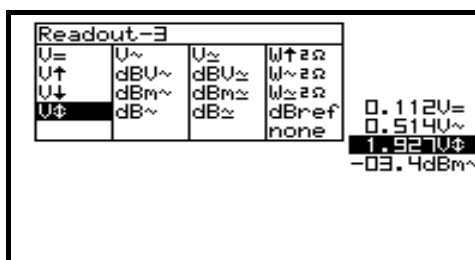

Fig 19

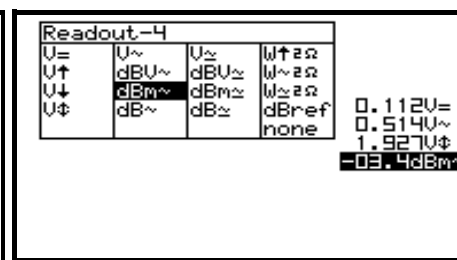

Fig 20

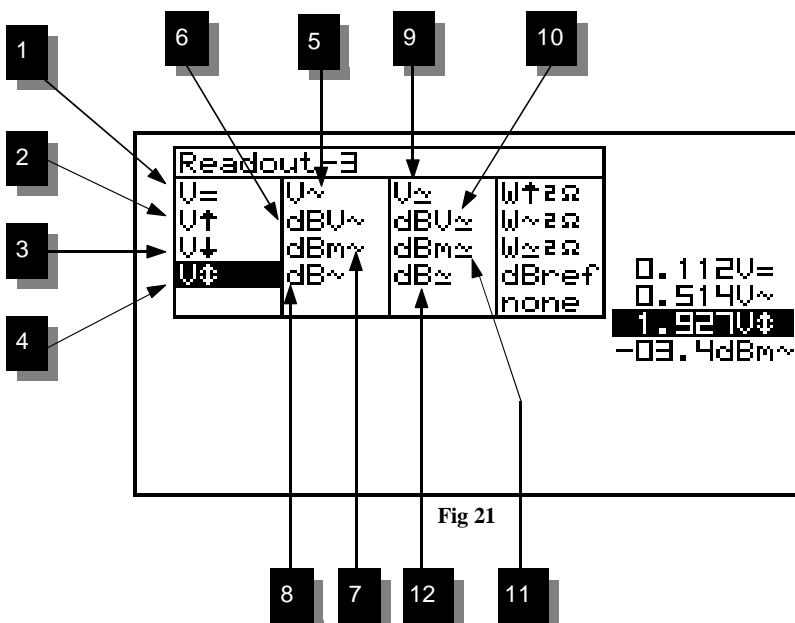

Fig 21

1. DC voltage measurement (V=).

This function enables the user to measure DC voltages (only for DC input coupling)

- Useful tip for measuring DC voltages: The readout can be set at zero (reference) for any position on the screen by keeping the AC/DC key pressed down. Always use the "run" trigger mode for DC voltage measurement.

2. Maximum voltage (Vmax.).

The signal's positive peak voltage (difference between zero and highest value) is displayed.

3. **Minimum voltage (Vmin.).**
The signal's negative peak voltage (difference between zero and lowest value) is displayed.
4. **Peak to peak (Vpp).**
The signal's peak-to-peak voltage (difference between highest and lowest value) is displayed.
5. **True RMS readout (Vrms ac)**
The true RMS value of the AC wave is calculated and converted to voltage.
6. **dBV measurement (dBV ac).**
The measured signal (ac only) is converted to dBv (0dB= 1V).
7. **dBm measurement (dBm ac).**
The measured signal (ac only) is converted to dBm (0dB= 0.775V).
8. **dB measurement (dB ac).**
The measured signal (ac only) is converted to dB (0dB= dBref*)
9. **True RMS readout (Vrms ac+dc)**
The true RMS value of the wave (ac+dc) is calculated and converted to voltage.
10. **dBV measurement (dBV ac+dc).**
The measured signal (ac+dc) is converted to dBv (0dB= 1V).
11. **dBm measurement (dBm ac+dc).**
The measured signal (ac+dc) is converted to dBm (0dB= 0.775V).
12. **dB measurement (dB ac+dc).**
The measured signal (ac+dc) is converted to dB (0dB=dBref)

***dB ref**

Select dBref to set the user defined reference for dB measurement; the selected meter will be set for dB measurement.

Audio power calculation.

The measured voltage is converted into power, supposing that the voltage is measured across an impedance. The calculated power can be displayed for loads of 2, 4, 8, 16 or 32 Ohm. To choose the different loads, first highlight the power readout and then press the right cursor key.

13. **W ac**
AC Rms power calculation into selected impedance (most used).
14. **W peak**
Peak power calculation into selected impedance.
15. **W ac+dc**
AC+DC power calculation into selected impedance (a normal audio signal can not have dc component).

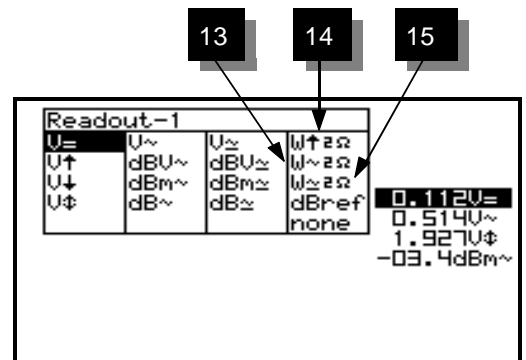

Fig 22

Notes:

- If the signal goes off-screen or when the signal is too small for measurement, the readout will show ??? (see fig 23)

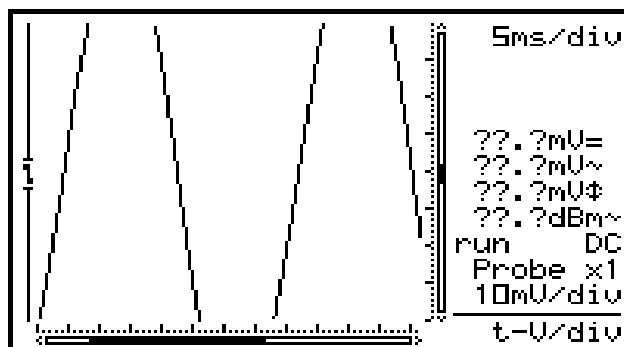
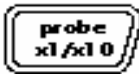

Fig 23

- For all AC measurements: Make sure that at least one or two periods are displayed or select the auto-setup function.
- You can choose “none” to hide readouts.
- Depending on the selected screen layout one to four different meter readouts can be displayed.
- At 1s/div timebase or slower, the readouts are forced to the instant information. ‘Vs’ (Fig. 25)
- If no key is pressed during 10 seconds, the unit returns to its previous operating mode and the cursorkeys are set for changing the timebase and sensitivity.



PROBE SETUP

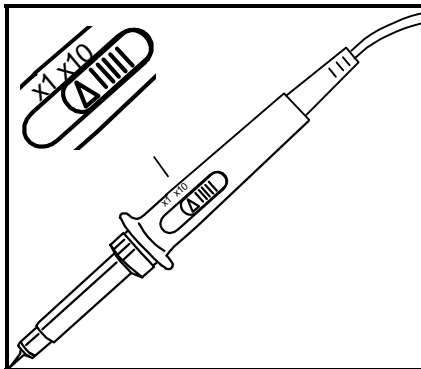

Fig 25 Press the ‘Probe x1/x10’-key to set the measurements accordingly the **x1/x10**-probe setting. (Fig. 25)

Notes:

- Automatically calculate the correct readouts depending the x1 or x10 probe setting.
- An ‘x10’ symbol is displayed if this mode has been selected.
- X10 measuring probes should be calibrated!
- **IMPORTANT:** Set the measuring probe in the x10 position for measuring high voltages (>100Vp+dc)

Setting up a X10 measuring probe

When used in the X10 position, a measuring probe should always be calibrated to the measuring instrument being used, in this case the Personal Scope. (Fig. 26)

- Open the battery cover.
- Set the scope to X10 position (probe x1/x10 key)
- Set the voltage per division to 1V
- Set the time per division to 0.1ms
- Select **AC** for the input.

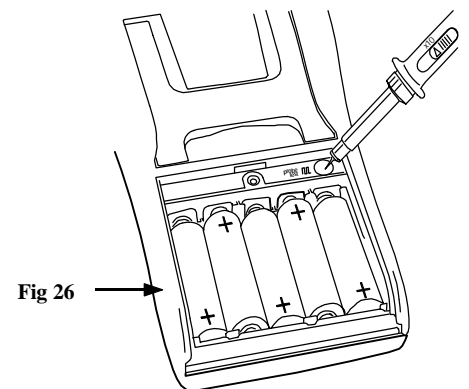

Fig 26

Use the probe to perform measurements at the pre-selected point under the battery cover. Adjust the trimmer of the measuring probe in order to obtain a square wave signal with a top that is as flat as possible. (Fig. 27)

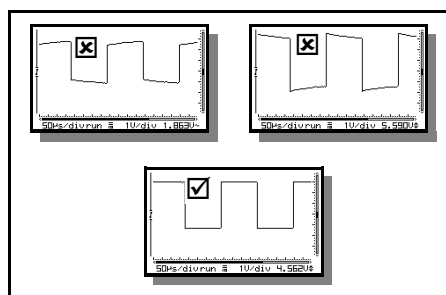

Fig 27

THE SIGNAL MARKERS

The user can perform measurements on a certain signal by using the four moveable markers. This can be useful when measuring the interval between two points or the amplitude of any given peak.

The following indications will appear on the screen:

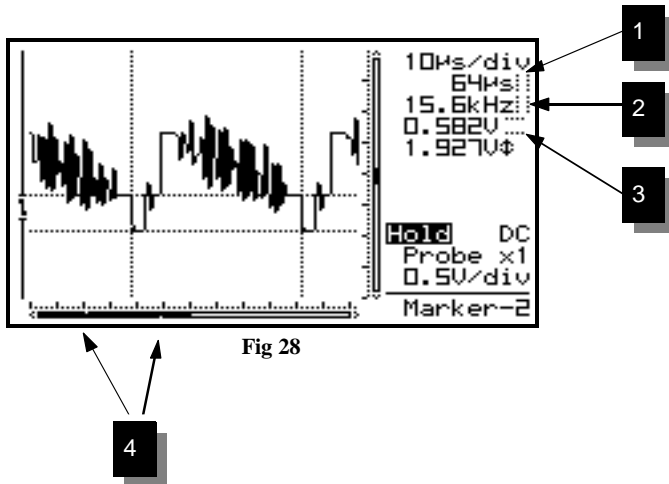

Fig 28

1. The time interval between two vertical markers.
2. The calculated frequency 1/Dt (primarily used for the measurement of periods).
3. The voltage between two horizontal markers.
4. Small dots indicating relative marker position on the complete signal. (**Just for HPS40**)

The markers can be moved through the arrow keys. Keeping the key pressed down will move the marker quickly, pressing it briefly will move the marker by 1 position. The “mark 1-2” key is used to select the desired marker.

☞ Determining the frequency of a signal requires the measurement of a period. The easiest way to do this would be by placing the vertical markers either on two consecutive peaks or two identical slopes of a signal.

Press the “Marker 1-2”- key to view, select or hide the markers. (1)
Press the cursor keys to move the markers. (2)

Notes:

- By pressing the ‘Marker 1-2’-key, you select between marker 1 or 2. The screen shifts automatically until the selected time marker is on screen.
- At dynamic display mode (see display set-up), the best display layout is chosen depending the use of time markers or voltage markers.
- Some meter readouts are replaced by the marker readouts.
- Depending on the chosen display layout, not all of the marker readouts can be displayed at the same time.
- Removing the markers from the screen can be done by repeatedly pressing the ‘Marker 1-2’-key or by a short press of the ‘Display’-key and using the up/down cursor keys.

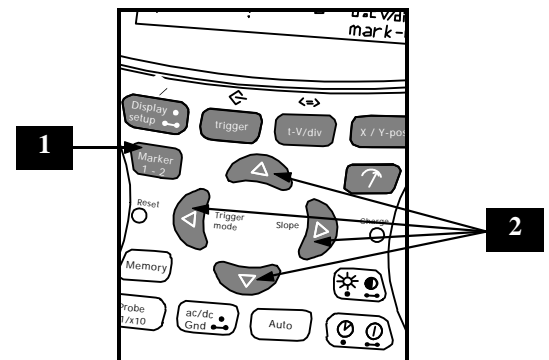

Fig 29

SIGNAL SCREEN

Press first the X/Y-pos key before pressing the arrow keys in order to move the signal in the direction of the arrows. Prolonged pressing will make the X or Y- position change faster.

A black bar (1) indicates the relative position of the signal in the sample window, see fig. 30. (**Only for HPS40**)

Just for HPS10:

A small dot in the left-hand corner of the screen will indicate the direction in which the signal has moved. In this manner the user will know in which direction the signal was going when it went off-screen.

Notes:

- The Y-position cannot be shifted in 'hold'-mode
- A total of 256 samples are stored in memory, but the X-size of the screen is limited. By shifting the X-direction you can display all stored samples.
- At dynamic display mode (set-up menu), the widest display layout is chosen by shifting the x-position.
- When no markers are displayed, the cursor keys are set for changing the time base or input sensitivity when no keys are pressed during 10 seconds

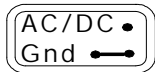

CHOICE OF INPUT COUPLING

Short press: Choice of input coupling ac (3) or dc (2). Depending on (part of) the signal to be measured, the input can be connected to the signal through a direct link or by using a decoupling capacitor. Select DC for measuring DC voltage. Press the "AC/DC" key to select either AC or DC input coupling (see indications on the screen).

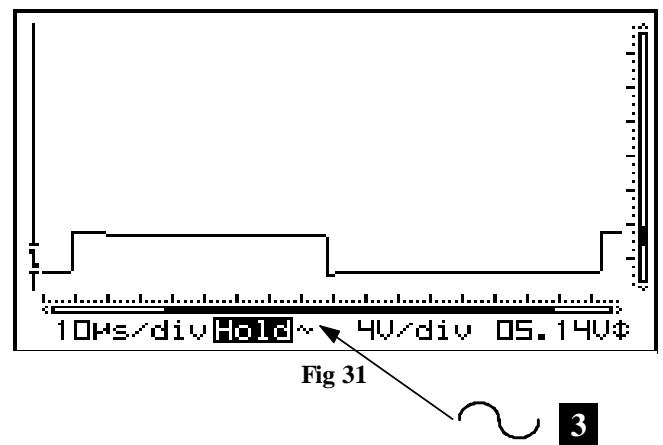
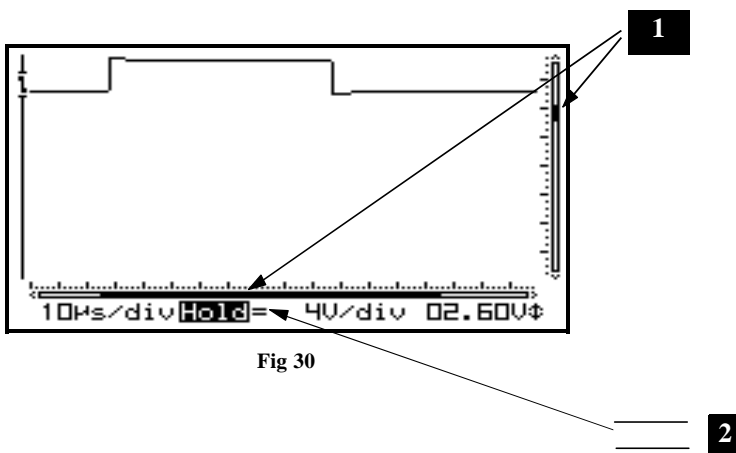

When measuring the "ripple" on a DC voltage: set the input to AC to limit the measurement to the AC component of the signal.

Note:

At time bases of 1s/div and slower, the input coupling is DC-only.

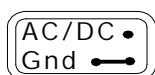

SET THE INPUT REFERENCE

Long Press: Switches the scope input to ground and stores the trace position as a new dc zero reference. Use this function to find and set the zero DC-reference trace on the screen.

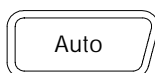

AUTO-SETUP FUNCTION

The auto-setup function is ideally suited for quick measurements as no manual setup has to be made and everything is automatic.

Use the auto-setup function when the screen no longer displays a signal after the manual setup.

Autorange on (Fig. 32):

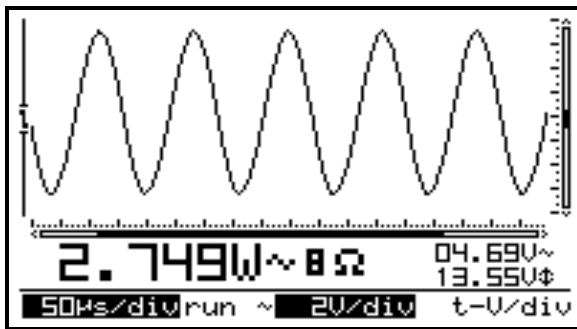

Fig 32

- Time/div and Volt/div settings are displayed inverted
- The time base and input sensitivity are automatically set for optimal viewing of the input signal.
- Auto-triggering is set for time base 2μs/div or slower, (HPS10 : 5μs/div)
- Normal triggering is set for time base faster then 2μs/div. (HPS10 : 5μs/div)
- The slowest possible time base is 5ms/div.
- The fastest possible time base is 250ns/div, (HPS10 : 1μs/div)
- Y-position is set to the center location.

Autorange off (Fig. 33) :

- Time/div and Volt/div settings are displayed in a normal font (not inverted)
- Cursor keys are set for changing the time base and input sensitivity.

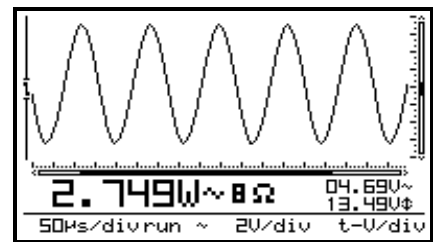
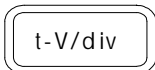

Fig 33

Note:

Changing the time base, input sensitivity, Y-pos or trigger mode turns off the auto range-mode.



CHANGING THE INPUT SENSITIVITY AND TIMEBASE

First press the „t-V/div“ key Use up/down cursorkeys for changing the input sensitivity (V/div) (Fig 34) Press the left/right cursorkeys for changing the timebase (time/div). (Fig 35)

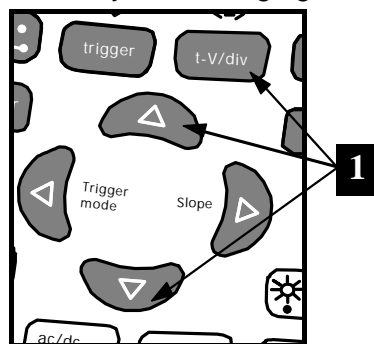

Fig 34

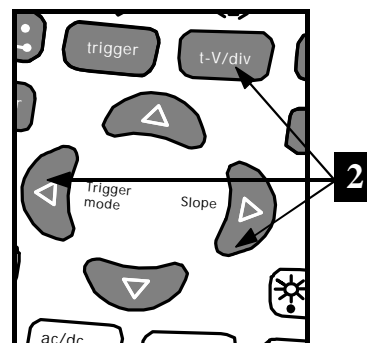

Fig 35

1. Changing Volt/div:

The signal on the screen can be enlarge or reduce vertically by adjusting the displayed voltage per division. (V/div = voltage per division). The divisions can be made visible through the Display set-up key (see display setup).

Select the sensitivity: from 5mV to a maximum of 20V per division.

☞ 50mV to 200V with X10 probe selection

Pressing the up cursor key increases the input sensitivity (lower value for V/div).

Pressing the down cursor key decreases the input sensitivity (higher value for V/div).

2. Changing the timebase:

Adjusting the time base will visualize more or fewer periods of a signal (t/div = time per division). The divisions can be visualized through the Display set-up key (see display setup). Set the time base between 1h and 50ns per division. (1h to 0,2μs for HPS10)

Press the 't-V/div'-key to set the cursorkeys action into 'timebase' mode.

Press the 'left' or 'right' cursor keys to increase or decrease the timebase (time/div).

Note:

- Changing the timebase or sensitivity switches the auto range mode immediately off. (Fig 36)
- The timebase or sensitivity cannot be changed into hold mode.
- Pressing the “t-V/div” key into hold mode toggles the screen between the two stored waveforms.
- At higher timebase (1µs and faster, 2µs for HPS10) the scope uses Oversampling mode, only repetitive signals are correctly displayed.
- Use the minimum time base (250ns) as a starting point when measuring a signal and select longer time bases until the signal is displayed properly. Otherwise the display may not correctly reflect the signal under measurement due to aliasing.

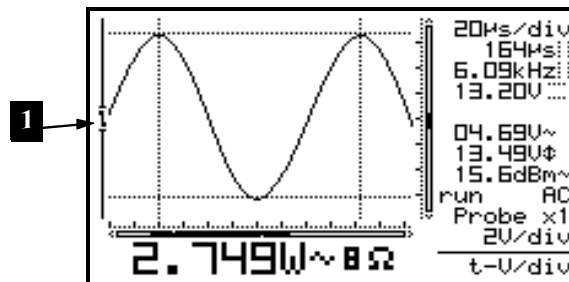

Fig 36

trig

THE TRIGGER SETUP

- First press the „trigger“-key.
- Use the left cursor key to change the triggermode (norm, run, once or roll).
- Use the right cursor key to toggle the trigger slope.
- Use the up/down cursorkeys to shift the vertical trigger position (1).

Trigger modes

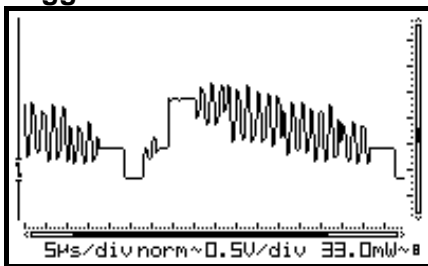

Fig 37

“norm” = Normal trigger: A triggering (or manual trigger) must occur before the sample memory is filled. Use this mode when you want to start displaying the signal when it reaches a preset threshold value. (Fig 37)

“Run” = Auto-trigger mode, the scope automatically triggers if no triggering occurs for a fixed period of time. This position is used most frequently and should always be used for measuring DC voltages in particular. (Fig 38)

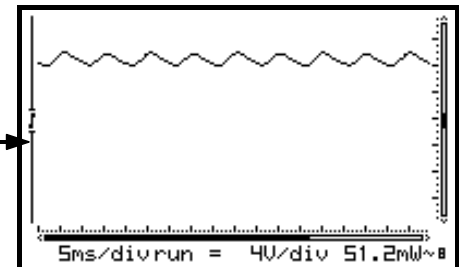

Fig 38

Trigger gap

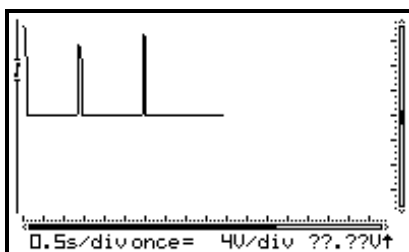

Fig 39

“Once” = Sampling starts after a trigger. Afterwards, the scope switches to ‘HOLD’-mode. Use this mode to detect e.g. a short, once-only voltage peak. (Fig 39)

“Roll” = Roll-mode is available for timebases of 1s/div or slower. Sampling is continuous and the screen starts rolling as soon as it is full. Use this position for “recording” slow moving signals. (Fig 40)

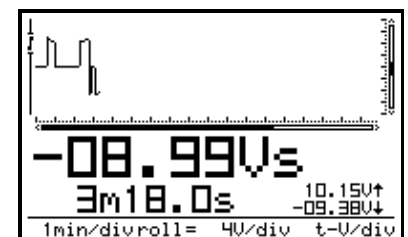

Fig 40

Notes:

- Pressing the Trigger key generates a manual triggering (except in 'HOLD'-mode)
- Changing the trigger mode switches the auto range mode immediately off.
- At time base of 1s/div and slower, the input coupling is DC-only
- Normal triggering is the only triggermode for timebases of 1 μ s/div or faster (2 μ s/div for HPS10) because of the oversampling method.
- Keep pressing this key during "hold" mode stores the current screen into memory.
- When no markers are displayed, the cursorkeys are set for changing the timebase or input sensitivity when no keys are pressed during 10 seconds.

Trigger slope

Press the right cursor key to set triggering at the rising or falling edge of the input signal.

1. Triggering on the rising slope of the signal: The screen will only display the signal when a positive slope is "detected", viz. the signal has to rise in vertical direction in order to trigger. **(Fig 41)**

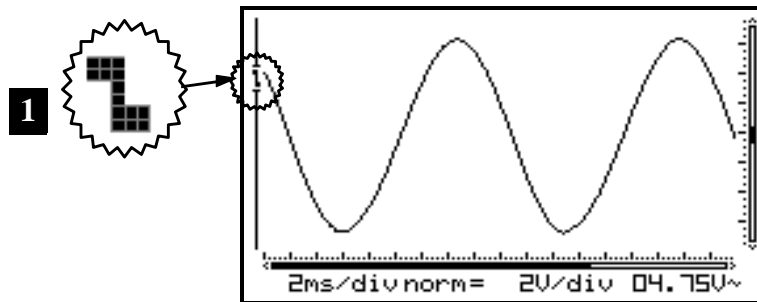

Fig 41

2. Triggering on the falling slope of the signal: The screen will only display the signal when a negative slope is "detected", viz. the signal has to drop in vertical direction in order to trigger. **(Fig 42)**

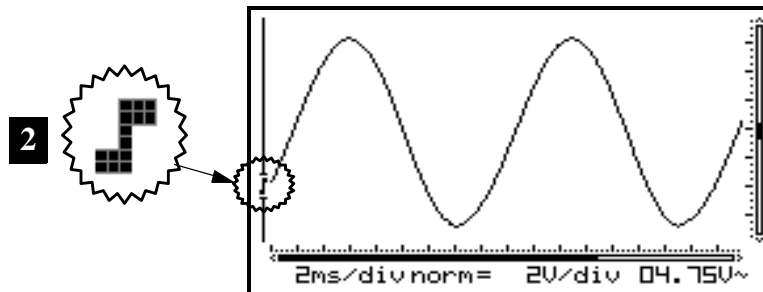

Fig 42

Notes:

Between triggering and the first sample-acquisition there is a fixed hardware-determined delay. Because of this delay, the sampled signal can show a different slope at fast timebases. When no markers are displayed, the cursorkeys are set for changing the timebase or input sensitivity when no keys are pressed during 10 seconds.

Changing the trigger level

Press the 'Trigger'-key to set the cursorkeys action into 'trigger' mode.

Press up/down cursor keys to shift the y-position of the signal

Or use the up/down cursorkeys to shift the vertical trigger position (1, 2). **(Only for HPS40)**

Notes:

- When no markers are displayed, the cursorkeys are set for changing the timebase or input sensitivity when no keys are pressed during 10 seconds.

Memory **HOLDING THE SCREEN**

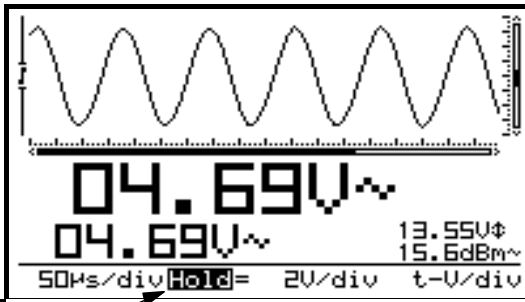

1 Fig 43

Press the **'Memory'**-key to freeze the waveform on-screen. It may be useful to **"freeze"** certain signals on your screen. This will allow the user to study the signal or perform measurements with the markers. **(Fig 43)**

Remarks:

- Most of the keyboard functions are disabled.
- Pressing the **Memory** key immediately stops sampling at slow timebases. The rest of the sample buffer will be cleared.
- **'HOLD'** will be displayed inverted. **(1)**
- Releasing the **'Hold'**-mode will remove the waveform from the screen.

Memory **STORE A SCREEN** 

Press the Memory key to **"Hold"** the waveform on-screen.
A long keypress of the **'Trigger'**-key mode stores the current screen into memory. **(2)**

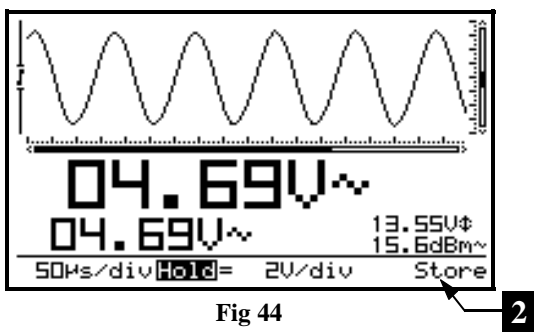

Fig 44

2

t-V/div **RECALL MEMORIES** 

Pressing the **'t-V/div'**-key when in hold mode toggles the screen between the frozen waveform and the stored waveform. „Mem“ is displayed if stored waveform is visible **(3)**

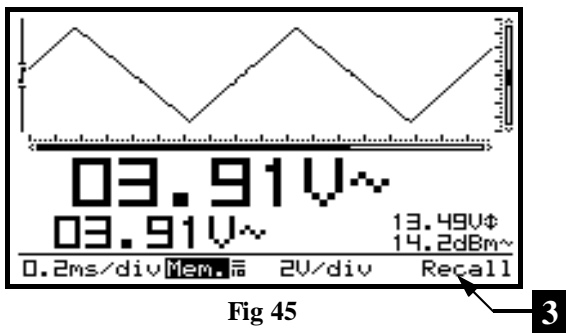

Fig 45

3

Notes:

- The store and recall- function is only available in **'HOLD'**-mode
- All setting such as timebase, input sensitivity, input coupling, probe setting and readouts are also stored into memory.



SENDING A SCREEN CAPTURE TO THE COMPUTER (Only for HPS40)

It is possible to send a screen picture to your computer using the RS232 output.

During „hold‘ mode press and keep pressing the memory key. A screen bit map (BMP) file will be send to the computer. A capture program can be downloaded from our site.

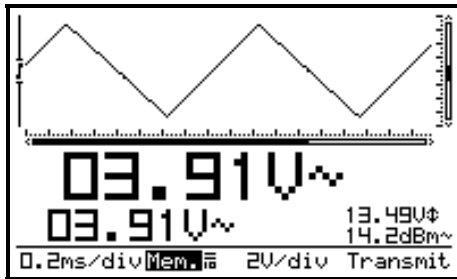

Fig 46

During normal measuring, press and hold the „memory“ key, to capture the screen.

„Transmit“ (1) is displayed briefly during the file transmit. (Fig.46)

1

RESETTING THE PERSONAL SCOPE (FIG. 47)

Press the sunk (1) 'Reset' push button for at least 10 seconds to return to the manufacture-programmed setup.

 **Note:**

- Use the reset function in case of unusual behaviour of the unit, like distorted screen or not functional keyboard (see also troubleshooting).
- Do not use a sharp tool.

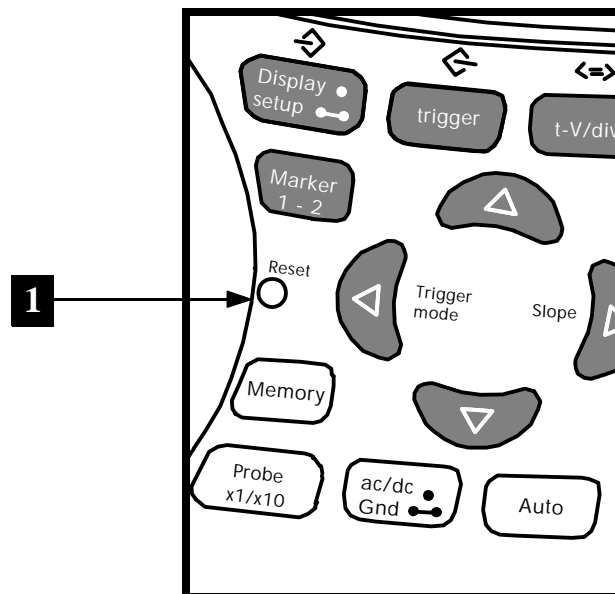

Fig 47

TROUBLESHOOTING

The screen remains blank or there is no signal:

- No power supply
- Batteries are discharged
- Contrast adjustment is incorrect
- Press RESET for at least 10 seconds

REMARK: Temporarily remove both batteries and adapter in case RESET is not helping.

RMS readout is incorrect:

- Make sure that at least 1 and preferably even 2 periods are displayed.
- The batteries are discharged.

No signal on the oscilloscope display:

- Time/div setting is in the wrong position. Try 1ms or choose auto-setup mode.
- The unit is in the Hold position
- Trigger function is set in the “once” position
- The programmed trigger level is not reached (choose “run” mode)
- Y position is wrong or need calibration, see page 11
- The input signal is too high, change the volt/div. setting or choose auto-setup.

Incorrect frequency readout:

- An incorrect time/div. setting has been chosen. (start at 250ns/div)

Voltage readout does not correspond with the actual value:

- The measuring probe is in the X10 position
- The batteries are discharged
- The zero reference is not set correctly for DC measurements.

RS232 Cable (Only for HPS40) :

3,5mm STEREO PLUG

9P SUB-D FEMALE

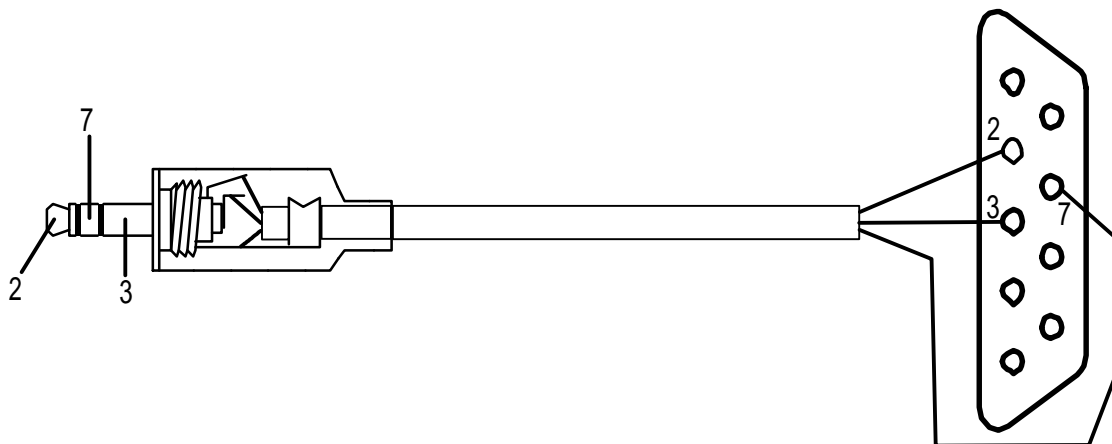

WARRANTY

This product carries a one-year warranty as far as the craftsmanship and possible flaws in the materials are concerned. The warranty expires ONE YEAR after the date of purchase. The warranty will only apply if the unit is wrapped in the original packing material and either presented to VELLEMAN COMPONENTS or to an official distributor together with a copy of the original purchasing document. VELLEMAN COMPONENTS is under the obligation to repair defects and flaws, but is free to either replace or repair defective parts. The warranty does not apply to software, fuses, measuring probes and batteries. VELLEMAN COMPONENTS will not be held responsible for any flaw or defect which the company feels is due to negligence on behalf of the user, to modification or opening of the unit, or to accidents or abnormal use or treatment of the product. VELLEMAN COMPONENTS will not reimburse the transport costs or risks, the costs for removing and replacing the product or any other costs that are directly or indirectly related to the defect. VELLEMAN COMPONENTS accepts no liability for whatever damages may be caused by a malfunctioning product.

MAINTENANCE

Clean the display with a shammy. NEVER use a dust cloth or paper in order to avoid scratches. The rest of the unit can be cleaned with a soft, dry cloth. NEVER use water to clean the unit

SPECIFICATIONS HPS40 :

Maximum sample rate	40MS/s for repetitive signals (10MS/s for single shot events)
Input amplifier bandwidth (-3dB)	From 5MHz at 5mV/div to 12MHz at 50mV, 1V & 20V /div
Input impedance	1Mohm // 20pF (standard oscilloscope probe)
Maximum input voltage	100Vpeak (AC + DC), 200Vpeak-peak (AC only)
Input coupling	DC, AC and GND (GND for auto zero reference)
Vertical resolution	8 bit \pm 1bit linearity
Trigger modes	Run, Normal, Once, Roll mode for 1s/div and slower timebase
Trigger level	Adjustable in 8 steps
LCD Graphics	112 x 192 pixels with LED backlight
Signal storage	256 samples with 2 memories, max. 179 samples visible (256 using X shift)
dBm measurement (0dBm= 0.775V in 600ohm)	From -73dB tot +40dB (up to 60dB with X10 probe) \pm 0.5dB accuracy
dBV measurements (0dBV= 1V)	From -75dB tot +38dB (up to 58dB with X10 probe) \pm 0.5dB accuracy
True-rms measurement	From 0.1mV to 80V (up to 400Vrms with X10 probe) 2.5% accuracy
Peak to peak AC sensitivity (sine wave ref.)	0.1mV to 160V (1mV to 1000V with x10 probe) 2% accuracy
Timebase range in 32 steps	50ns to 1hour / division
Input sensitivity range in 12 steps	5mV to 20V/division at X1 - 50mV to 200V/div at X10
Probe calibration output	Approx. 2KHz / 4.5Vpp
Supply voltage	9VDC/ min 300mA adapter (unregulated) 12VDC if regulated
Batteries (option)	Alkaline type AA or Ni Cd / NiMH rechargeable (5 pcs required)
Charge current for rechargeable batteries	90mA
Battery current (average)	On: 170mA, with backlight: 240mA, standby current: < 600 μ A
Operating temperature	0 to 50°C (32 to 122°F)
Physical characteristics	Dim: 105x220x35mm (4.13x7.95x1.38") Weight 450g (16oz.) ex.Batteries

SPECIFICATIONS HPS10 :

Maximum sample rate	10MHz for repetitive signals (2MHz for single shot events)
Maximum input amplifier bandwidth	2MHz (-3dB at 50mV, 1V & 20V /div x1 setting)
Input impedance	1Mohm // 20pF (standard oscilloscope probe)
Maximum input voltage	100Vpeak (AC + DC), 200Vpeak-peak (AC only)
Input coupling	DC, AC and GND (GND for auto zero reference)
Vertical resolution	8 bit ? 1bit linearity
Trigger modes	Run, Normal, Once, Roll mode for 1s/div and slower timebase
LCD Graphics	64 x 128 pixels
Signal storage	256 samples with 2 memories, max. 125 samples visible (256 using X shift)
dBm measurement (0dBm= 0.775V in 600ohm)	From -73dB tot +40dB (up to 60dB with X10 probe) ± 0.5 dB accuracy
dBV measurements (0dBV= 1V)	From -75dB tot +38dB (up to 58dB with X10 probe) ± 0.5 dB accuracy
True-rms measurement	From 0.1mV to 80V (up to 400Vrms with X10 probe) 2.5% accuracy
Peak to peak AC range (sine wave reference)	0.1mV to 160V (1mV to 1200V with x10 probe) 2% accuracy
Timebase range in 32 steps	0.2 μ s to 1hour / division
Input sensitivity range in 12 steps	5mV to 20V/division at X1 - 50mV to 200V/div at X10
Probe calibration output	Approx. 2KHz / 5Vpp
Supply voltage	9VDC/ min 300mA adapter (unregulated) 12VDC if regulated
Batteries (option)	Alkaline type AA or Ni Cd / NiMH rechargeable (5 pcs required)
Charge current for rechargeable batteries	90mA
Battery life	Up to 20h with Alkaline batteries (OFF or standby current < 500 μ A)
Operating temperature	0 to 50°C (32 to 122°F)
Physical characteristics	Dim: 105x220x35mm (4.13x7.95x1.38") Weight 395g (14oz.) ex. Batteries



Legen Heirweg 33, 9890 Gavere

Belgium Europe

+32 (0)9 3843611

<http://www.velleman.be>

France

VELLEMAN ELECTRONIQUE

+33 (0) 320158615

Netherlands

VELLEMAN COMPONENTS

+31 (0) 765147563

USA

VELLEMAN INC.

+1 (817) 284 7785