

NPN-Silizium-Fototransistor Silicon NPN Phototransistor

BPX 43

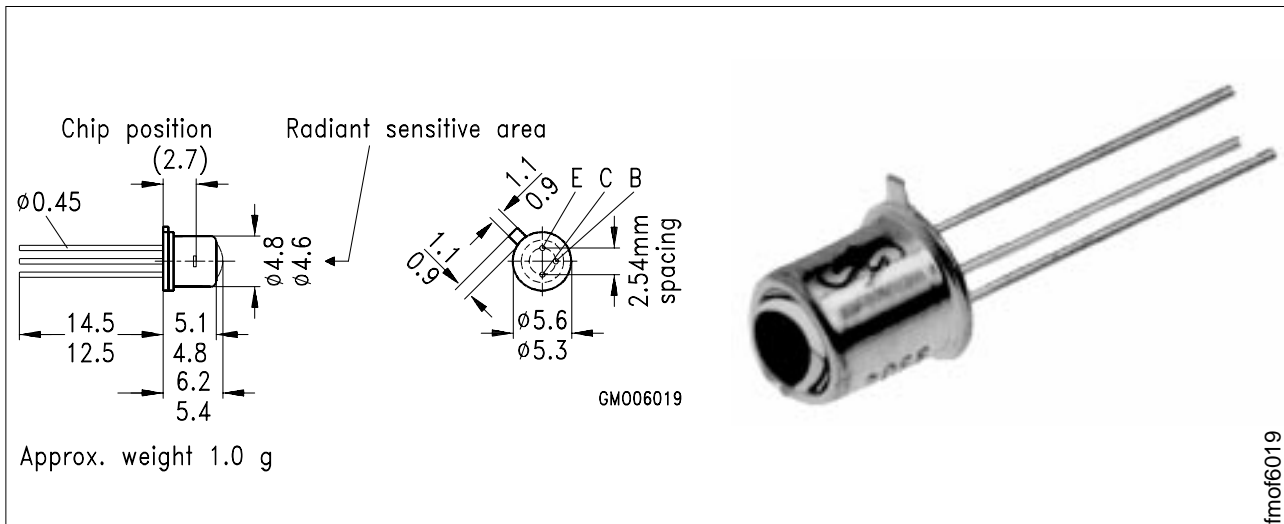

Maße in mm, wenn nicht anders angegeben/Dimensions in mm, unless otherwise specified

Wesentliche Merkmale

- Speziell geeignet für Anwendungen im Bereich von 450 nm bis 1100 nm
- Hohe Linearität
- Hermetisch dichte Metallbauform (TO-18) mit Basisanschluß, geeignet bis 125 °C
- Gruppier lieferbar

Anwendungen

- Lichtschranken für Gleich- und Wechsellichtbetrieb
- Industrieelektronik
- "Messen/Steuern/Regeln"

Features

- Especially suitable for applications from 450 nm to 1100 nm
- High linearity
- Hermetically sealed metal package (TO-18) with base connection suitable up to 125 °C
- Available in groups

Applications

- Photointerrupters
- Industrial electronics
- For control and drive circuits

Typ Type	Bestellnummer Ordering Code
BPX43	Q62702-P16
BPX 43-2	Q62702-P16-S2
BPX 43-3	Q62702-P16-S3
BPX 43-4	Q62702-P16-S4
BPX 43-5	Q 62702-P16-S5

Grenzwerte
Maximum Ratings

Bezeichnung Description	Symbol Symbol	Wert Value	Einheit Unit
Betriebs- und Lagertemperatur Operating and storage temperature range	$T_{op}; T_{stg}$	- 40 ... + 100	°C
Löttemperatur bei Tauchlötung Lötstelle ≥ 2 mm vom Gehäuse, Lötzeit $t \leq 5$ s Dip soldering temperature ≥ 2 mm distance from case bottom, soldering time $t \leq 5$ s	T_S	260	°C
Löttemperatur bei Kolbenlötung Lötstelle ≥ 2 mm vom Gehäuse, Lötzeit $t \leq 3$ s Iron soldering temperature ≥ 2 mm distance from case bottom, soldering time $t \leq 3$ s	T_S	300	°C
Kollektor-Emitterspannung Collector-emitter voltage	V_{CE}	50	V
Kollektorstrom Collector current	I_C	50	mA
Kollektorspitzenstrom, $\tau < 10 \mu s$ Collector surge current	I_{CS}	200	mA
Emitter-Basisspannung Emitter-base voltage	V_{EB}	7	V
Verlustleistung, $T_A = 25 \text{ °C}$ Total power dissipation	P_{tot}	220	mW
Wärmewiderstand Thermal resistance	R_{thJA}	450	K/W

Kennwerte ($T_A = 25\text{ °C}$, $\lambda = 950\text{ nm}$)

Characteristics

Bezeichnung Description	Symbol Symbol	Wert Value	Einheit Unit
Wellenlänge der max. Fotoempfindlichkeit Wavelength of max. sensitivity	$\lambda_{S_{max}}$	880	nm
Spektraler Bereich der Fotoempfindlichkeit $S = 10\%$ von S_{max} Spectral range of sensitivity $S = 10\%$ of S_{max}	λ	450 ... 1100	nm
Bestrahlungsempfindliche Fläche Radiant sensitive area	A	0.675	mm ²
Abmessung der Chipfläche Dimensions of chip area	$L \times B$ $L \times W$	1 × 1	mm × mm
Abstand Chipoberfläche zu Gehäuseoberfläche Distance chip front to case surface	H	2.4 ... 3.0	mm
Halbwinkel Half angle	φ	± 15	Grad deg.
Fotostrom der Kollektor-Basis-Fotodiode Photocurrent of collector-base photodiode $E_e = 0.5\text{ mW/cm}^2$, $V_{CB} = 5\text{ V}$ $E_v = 1000\text{ lx}$, Normlicht/standard light A, $V_{CB} = 5\text{ V}$	I_{PCB} I_{PCB}	11 35	μA μA
Kapazität Capacitance $V_{CE} = 0\text{ V}$, $f = 1\text{ MHz}$, $E = 0$ $V_{CB} = 0\text{ V}$, $f = 1\text{ MHz}$, $E = 0$ $V_{EB} = 0\text{ V}$, $f = 1\text{ MHz}$, $E = 0$	C_{CE} C_{CB} C_{EB}	23 39 47	pF pF pF
Dunkelstrom Dark current $V_{CE} = 25\text{ V}$, $E = 0$	I_{CEO}	20 (≤ 300)	nA

Die Fototransistoren werden nach ihrer Fotoempfindlichkeit gruppiert und mit arabischen Ziffern gekennzeichnet.

The phototransistors are grouped according to their spectral sensitivity and distinguished by arabian figures.

Bezeichnung Description	Symbol Symbol	Wert Value				Einheit Unit
		-2	-3	-4	-5	
Fotostrom, $\lambda = 950 \text{ nm}$ Photocurrent $E_e = 0.5 \text{ mW/cm}^2$, $V_{CE} = 5 \text{ V}$ $E_v = 1000 \text{ lx}$, Normlicht/standard light A, $V_{CE} = 5 \text{ V}$	I_{PCE} I_{PCE}	0.8 ... 1.6 3.8	1.25 ... 2.5 6.0	2.0 ... 4.0 9.5	≥ 3.2 15.0	mA mA
Anstiegszeit/Abfallzeit Rise and fall time $I_C = 1 \text{ mA}$, $V_{CC} = 5 \text{ V}$, $R_L = 1 \text{ k}\Omega$	t_r , t_f	9	12	15	18	μs
Kollektor-Emitter-Sättigungsspannung Collector-emitter saturation voltage $I_C = I_{PCEmin}^{1)} \times 0.3$ $E_e = 0.5 \text{ mW/cm}^2$	V_{CEsat}	200	220	240	260	mV
Stromverstärkung Current gain $E_e = 0.5 \text{ mW/cm}^2$, $V_{CE} = 5 \text{ V}$	$\frac{I_{PCE}}{I_{PCB}}$	110	170	270	430	

1) I_{PCEmin} ist der minimale Fotostrom der jeweiligen Gruppe

1) I_{PCEmin} is the min. photocurrent of the specified group

Relative spectral sensitivity

$$S_{rel} = f(\lambda)$$

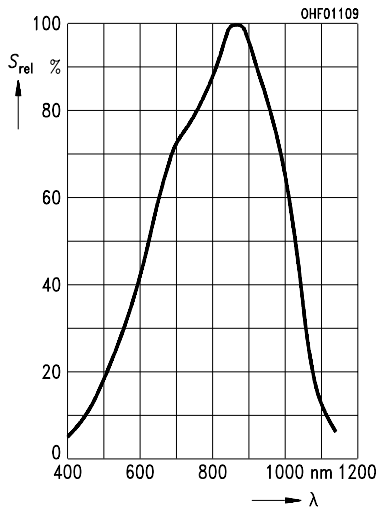

Photocurrent

$$I_{PCE} = f(E_e), V_{CE} = 5 \text{ V}$$

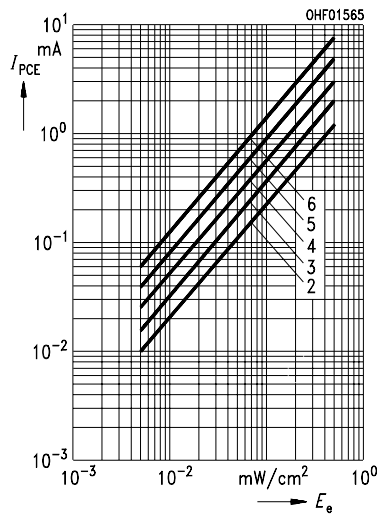

Total power dissipation

$$P_{tot} = f(T_A)$$

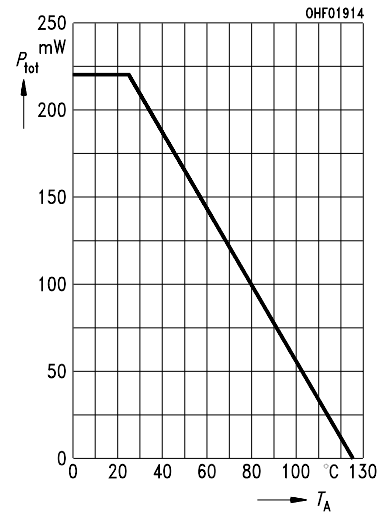

Output characteristics

$$I_C = f(V_{CE}), I_B = \text{Parameter}$$

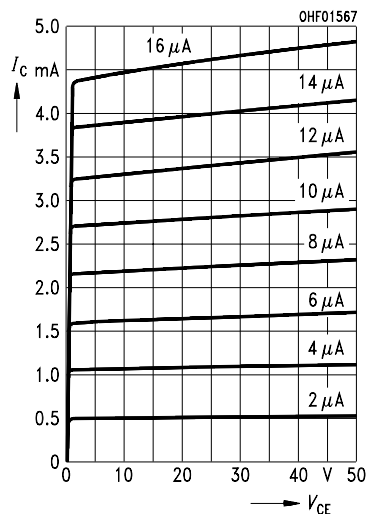

Output characteristics

$$I_C = f(V_{CE}), I_B = \text{Parameter}$$

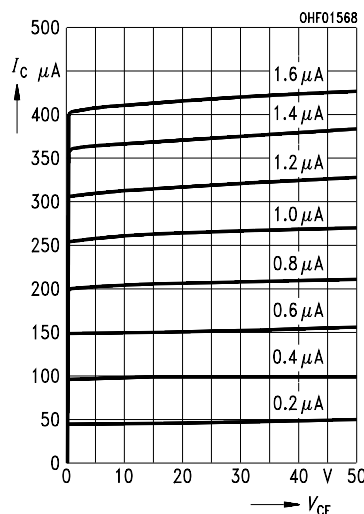

Dark current

$$I_{CEO} = f(V_{CE}), E = 0$$

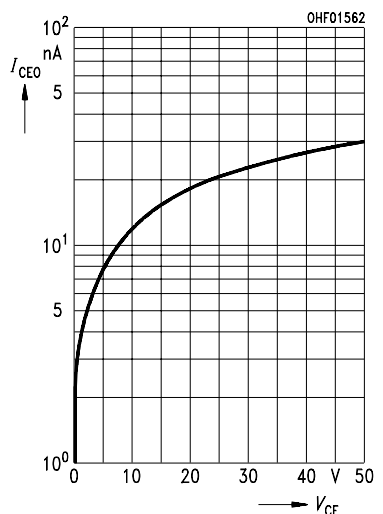

Photocurrent

$$I_{PCE}/I_{PCE25^\circ} = f(T_A), V_{CE} = 5 \text{ V}$$

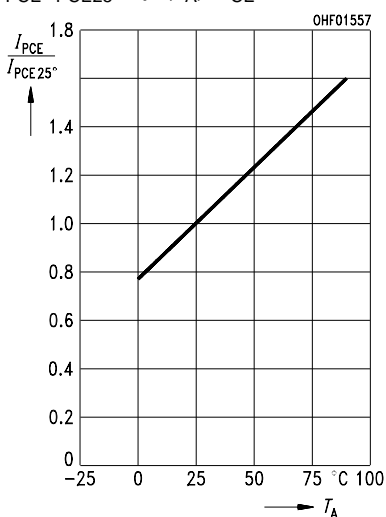

Dark current

$$I_{CEO}/I_{CEO25^\circ} = f(T_A), V_{CE} = 25 \text{ V}, E = 0$$

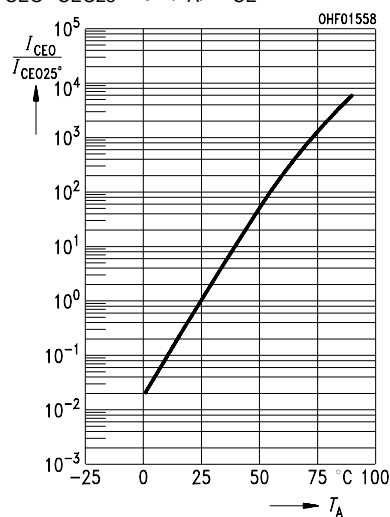

Collector-emitter capacitance

$$C_{CE} = f(V_{CE}), f = 1 \text{ MHz}, E = 0$$

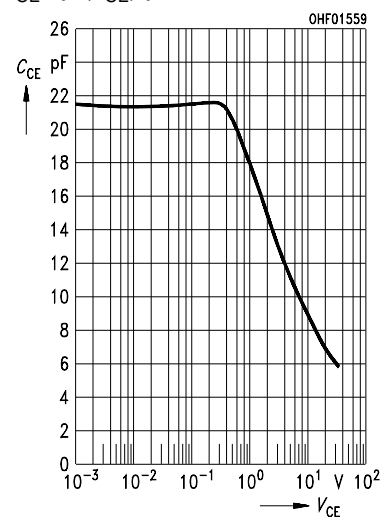

Collector-base capacitance

$$C_{CB} = f(V_{CB}), f = 1 \text{ MHz}, E = 0$$

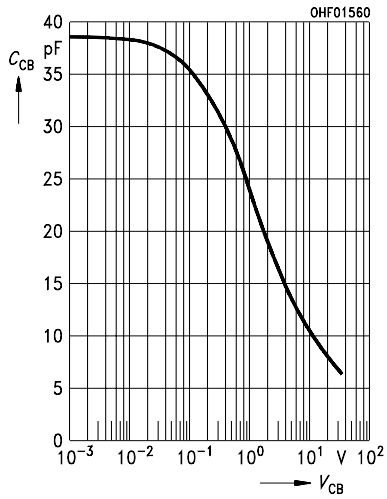

Emitter-base capacitance

$$C_{EB} = f(V_{EB}), f = 1 \text{ MHz}, E = 0$$

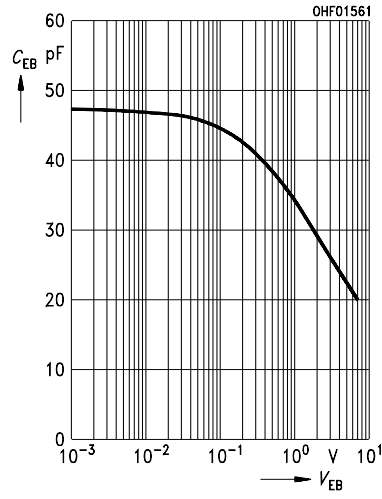

Directional characteristics $S_{rel} = f(\varphi)$

