

Technical Specifications

ENVIRONMENTAL CONDITIONS	
Ambient/storage temperature	0 ... +50°C/-25... +70°C, without condense
Max. relative humidity	80% up to 31°C decreasing linearly 50% at 40°C.
Rated pollution degree	According to EN 60529 Front panel : IP60 Rare panel : IP20
Height	Max. 2000m

⚠ Do not use the device in locations subject to corrosive and flammable gases.

ELECTRICAL CHARACTERISTICS	
Supply	230V AC +10% -20%, 50/60Hz or 24V AC ±10%, 50/60Hz
Power consumption	Max. 5VA
Input / Wiring	Thermocouple "J" type / 1.5mm ² screw-terminal connection.
Scale	0 ... 400°C
Sensitivity	1°C
Accuracy	For adjustment ±4%, for display ±0,5% (of full scale) or ±1 digit.
Display	3 digits, 7.62mm, 7 seven segment LED
Data retention	EEPROM (>10 years)
EMC	EN 61326-1: 1997, A1: 1998, A2: 2001 (For EMC tests performance criterion B is satisfied.)
Safety requirements	EN 61010-1: 2001 (Pollution degree 2, overvoltage category II)

OUTPUT	
Control output	Relay : 250V AC, 2A (for resistive load), NO+NC or 12V DC 20mA logic output
Life expectancy for relay	Mechanical 30.000.000 operation; electrical 300.000 operation

CONTROL	
Control type	Single-setpoint control
Control algorithm	On-Off / time proportional (optional)
A/D converter	9 bits
Proportional band	2% (for time porportional control)
Control period	10 second (for time proportional control)
Hysteresis	4°C (for On-Off control)

HOUSING	
Housing type	Suitable for flush-panel mounting.
Dimensions	W96xH96xD50mm
Weight	Approx. 340g (after packing)
Enclosure material	Self extinguishing plastics

⚠ While cleaning the device, don't use solvents (thinner, benzene, acid etc.) or corrosive materials

Dimensions

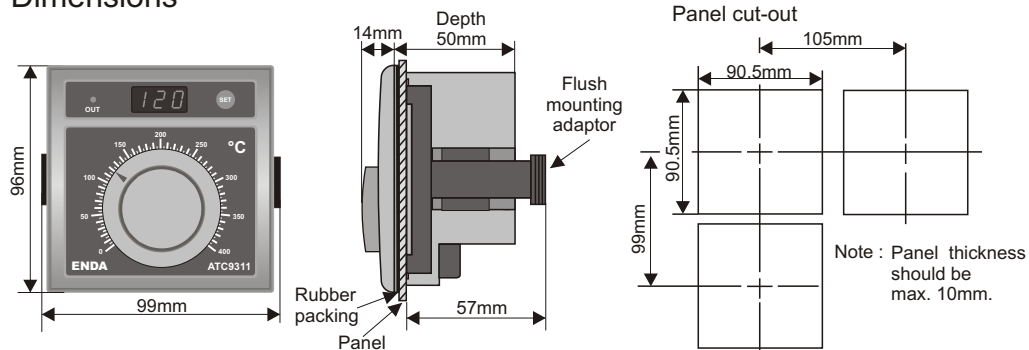

english



Read this document carefully before using this device. The guarantee will be expired by damaging of the device if you don't attend to the directions in the user manual. Also we don't accept any compensations for personal injury, material damage or capital disadvantages.

ENDA ATC9311

ANALOG THERMOSTAT with DIGITAL DISPLAY

Thank you for choosing ENDA ATC9311 temperature controller.



- * 96 x 96mm sized.
- * Digital display for measured temperature and set value.
- * Selectable On-Off or time proportional control.
- * Fe-CuNi "J" type thermocouple input.
- * Output relay is deenergised in the case of sensor failure.
- * Easy setting procedure.

Application areas

glass industry, chemistry and pharmacy, drinks industry, drying plant, paper industry, food industry, baker's plant, plastic industry

up to date: 03072010, modification reserved and can be change any time previous notice !

ATC9311 Programming Diagram

Set value

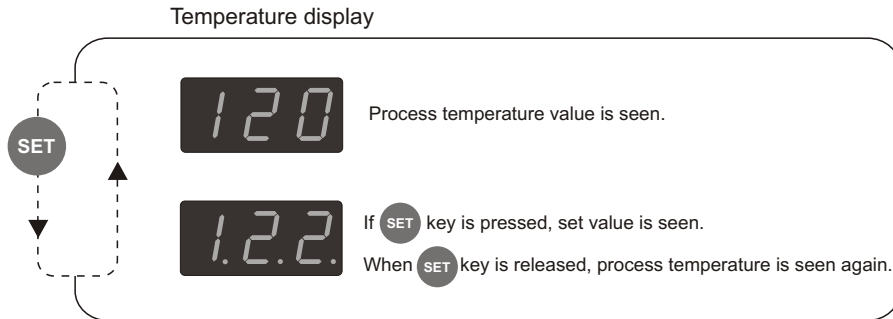

Selecting control form

When the device is energised, selected control form is seen on the display.

If time proportional control was selected, **LP** is seen.

If On-Off control was selected, **on-** and **off** are seen.

If the device is energised while holding SET key, control form changes and the related message is seen on the display.

Error Messages

PFA

If this message is seen, it means temperature sensor was not disconnected or over temperature condition was occurred. When this message is seen,

Err

If this message is seen, it means the device has a calibration error. In this case, the device should be sent to your trader, or to a nearest ENDA local representative for calibration and testing. When this message is seen, the control output is deenergised.

Connection diagram



ENDA ATC9311 is intended for installation in control panels. Make sure that the device is used only for intended purpose. The electrical connections must be carried on by a qualified staff and must be according to the relevant locally applicable regulations. During an installation, all of the cables that are connected to the device must be free of energy. The device must be protected against inadmissible humidity, vibrations, severe soiling and make sure that the operation temperature is not exceeded. All input and output lines that are not connected to the supply network must be laid out as shielded and twisted cables. These cables should not be close to the power cables or components. The shielding must be grounded on the instrument side.

Terminal connection

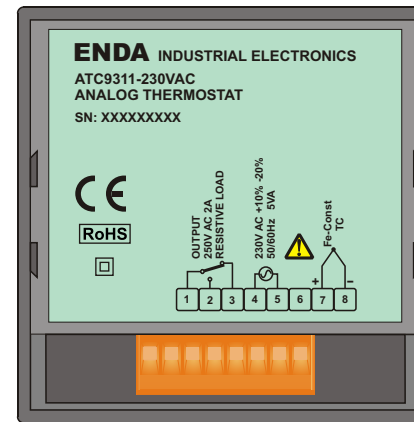

Terminal connection

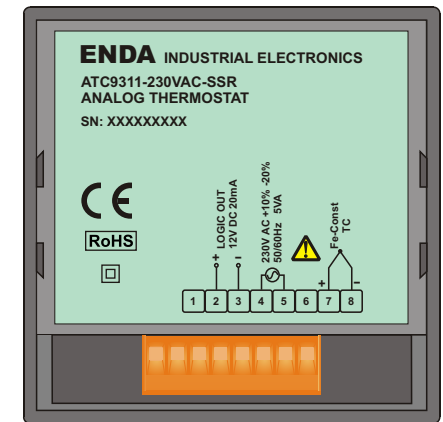

NOTE :

Supply :

184-253V AC (4)
50/60Hz 5VA (5)

The fuse for the load is not considered !

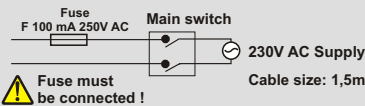

SENSOR INPUT :

Use suitable compensation cables. Don't use jointed cables. Pay attention to the polarities of the thermocouple cables as shown in the figure below.

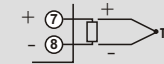

Logic output of the instrument ATC9311-SSR is electrically not insulated from the internal circuits. Therefore, when using a grounding thermo-couple, do not connect the logic output terminals to the ground.

Note :

- 1) Cables for supply must be IEC60799 or IEC60245 conform.
- 2) Main switch should be with in easy reach and should be indicated !

Note :

The time proportional function controls a temperature area near the SET value. Out of this temperature range the relay is "OFF" by over the SET value or "ON" under the SET value. If the process value approximated to SET value, the "ON" time from the relay will be shortly. The process temperature will be prevented to swing or will be very small.

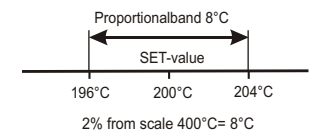

Supply voltage	Control output	Order code
230V AC +10% -20%	Relay	ATC9311
	Logic output	ATC9311-SSR
24V AC ±10%	Relay	ATC9311-24
	Logic output	ATC9311-24-SSR