



Read this document carefully before using this device. The guarantee will be expired by damaging of the device if you don't attend to the directions in the user manual. Also we don't accept any compensations for personal injury, metarial damage or capital disadvantages.

english

ENDA ETC SERIES PID TEMPERATURE CONTROLLERS

Thank you for choosing ENDA ETC SERIES temperature controllers

- * Selectable sensor type.
- * Automatic calculation of PID parameters (SELF TUNE).
 - ⚠ Enter PID parameters of the system if they are known at the begining. Otherwise, Self-Tune should be activated.
- * Soft-Start.
- * Communication via RS-485 ModBus protocol (Optional).
- * Selectable SSR or relay control output.
- * Relay output can be programmable as second alarm or control output.
- * AL1 relay output for first alarm out.
- * Selectable Heat/Cool control.
- * Input offset feature.
- * In the case of sensor failture periodical running or relay state can be selected.
- * Parameter access protection on 3 levels.
- * Programming by using keypad or Modbus.
- * CE marked according to European Norms.



RoHS Compliant



Order Code : ETC - -

- | | | |
|-----------------------|----------------------------|--|
| 1 - Dimensions | 2 - Supply Voltage | 3 - Modbus Option |
| 4420.....48x48x87mm | 230VAC...230V AC | RS.....RS-485 Modbus communication |
| 7420.....72x72x97mm | 24VAC.....24V AC | None.....Don't support RS-485 Modbus comm. |
| 8420.....48x96x87mm | SM.....9-30V DC / 7-24V AC | |
| 9420.....96x96x50mm | | |

TECHNICAL SPECIFICATIONS

Input type	Temperature range
J (Fe-CuNi) Thermocouple EN 60584	0... 600°C +32... +1112°F
K (NiCr-Ni) Thermocouple EN 60584	0...1200°C +32... +2192°F
T (Cu-CuNi) Thermocouple EN 60584	0... 400°C +32... +752°F
S (Pt10Rh-Pt) Thermocouple EN 60584	0...1600°C +32... +2912°F
R (Pt13Rh-Pt) Thermocouple EN 60584	0...1600°C +32... +2912°F
Pt 100 Resistance thermometer EN 60751	-200...600°C -328... +1112°F
Pt 100 Resistance thermometer EN 60751	-99.9...300.0°C -99.9...+543.0°F

ENVIROMENTAL CONDITIONS	
Ambient/storage temperature	0 ... +50°C / -25... +70°C (with no icing)
Max. Relative humidity	80% up to 31°C decreasing linearly 50% at 40°C .
Rated population degree	According to EN 60529 Front panel : IP65 Rear panel : IP20
Height	Max. 2000m

⚠ Do not use the device in locations subject to corrosive and flammable gases.

ELECTRICAL CHARACTERISTICS	
Supply	230VAC +%10 -%20 or 24VAC ±%10, 50/60Hz or by your choose 9-30VDC / 7-24VAC ±%10 SMPS
Power consumption	Max. 7VA (For ETC4420 5VA)
Wiring	2.5mm ² screw-terminal connections
Line resistance	For thermocouple max. 100ohm, for 3 wired Pt 100 max. 20ohm
Accuracy	± 0,2% (of full scale) ±1 digit
Data retention	EEPROM (minimum 10 years)
EMC	EN 61326-1:1997, A1:1998, A2:2001 (Performance criterion B for standard EN 61000-4-3)
Safety requirements	EN 61010-1: 2001 (Pollution degree 2, overvoltage category II)

OUTPUTS	
CONT./AL2	Relay : 250V AC, 2A (for resistive load), Selectable as Control or Alarm2 output.
AL1	Relay : 250V AC, 2A (for resistive load), NO/NC selectable. (Alarm1 output).
SSR out	Selectable logic control output. (Max 12V 20mA).
Life expectancy for relay	Mechanical 30.000.000 operation; Electrical 300.000 operation

CONTROL	
Control type	Single set-point and alarm control
Control algorithm	On-Off / P, PI, PD, PID (selectable)
A/D converter	Better than 15 bits
Sampling time	500ms
Propotional band	Adjustable between %0 and %100. If $Pb=0$, On-Off control is selected.
Integral time	Adjustable between 0.0 and 100.0 minutes.
Derivative time	Adjustable between 0.00 and 25.00 minutes.
Control period	Adjustable between 1 and 250 seconds.
Hysteresis	Adjustable between 1 and 50°C/F .if $mP=Pt.D$, adjustable between 0,1 and 50°C/F)
Output power	The ratio of power at a set point can be adjusted between 0% and 100%

HOUSING	
Housing type	Suitable for flush-panel mounting according to DIN 43 700.
Dimensions	ETC4420 : G48xY48xD87mm ETC7420 : G72xY72xD97mm ETC8420 : G48xY96xD87mm ETC9420 : G96xY96xD50mm
Weight	Approximately 400g after packing (For ETC4420 250g).
Enclosure material	Self extinguishing plastics.

⚠ While cleaning the device, solvents (thinner, benzine, acid etc.) or corrosive materials must not be used.

TERMS

PV Display :
Process value during normal operation
Mnemonic parameter code during programming

SV Display :
Set point during normal operation
Date value during programming

SET Control set key during normal operation
CSET Parameter selection key during programming

▶ Alarm set key during normal operation
ASET Menu selection key during programming

▲ Increment key during normal operation and programming
Parameter selection key during programming

▼ Decrement key during normal operation
If only this key is pressed in normal operation, software version number is seen

PV display	7 segment, 4 digits, red LED indicator yellow LED ind.(ETC8420)
SV display	7 segment, 4 digits, yellow LED indicator
Character heights	PV display : 7mm(ETC4420) 12.5mm(ETC8420) 14mm(ETC7420) 20.3mm(ETC9420) SV display : 7mm(ETC4420) 12.5mm(ETC8420) 10.2mm(ETC7420) 14mm(ETC9420)
Keypad	Mikro Switch
State indicator	3 red LEDs for Control, Alarm1 and SSR outputs

CONNECTION DIAGRAM



ENDA ETC series are intended for installation in control panels. Make sure that the device is used only for intended purpose. The shielding must be grounded on the instrument side. During an installation, all of the cables that are connected to the device must be free of energy. The device must be protected against inadmissible humidity, vibrations, severe soiling and make sure that the operation temperature is not exceeded. All input and output lines that are not connected to the supply network must be laid out as shielded and twisted cables. These cables should not be close to the power cables or components. The installation and electrical connections must be carried on by a qualified staff and must be according to the relevant locally applicable regulations.

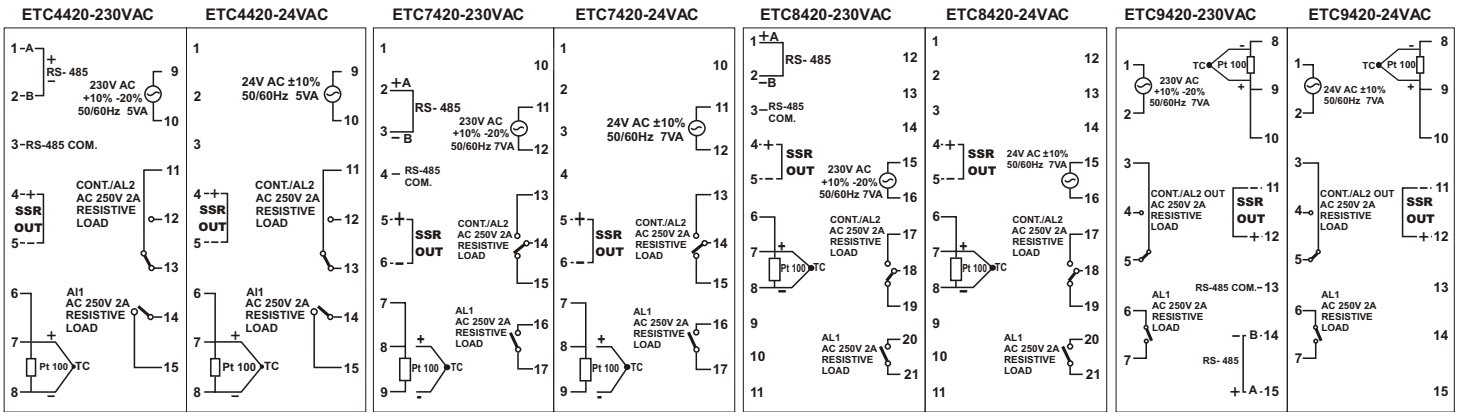

NOTE :

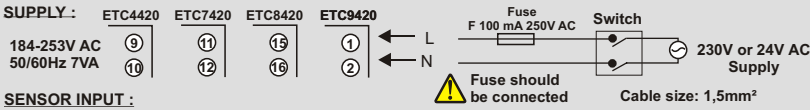

Holding screw 0.4-0.5Nm

Equipment is protected throughout by DOUBLE INSULATION

SENSOR INPUT :

For J-K-T-S-R type thermocouple :

Use suitable compensation cables. Don't use jointed cables. Pay attention to the polarities of the thermocouple cables as shown in the figure right are connected to the.

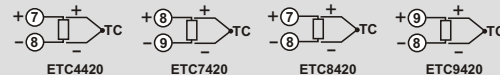

For resistance thermometer :

When 2 wired Pt 100 is used, terminals that are shown at the right of there must be short circuited for each product.

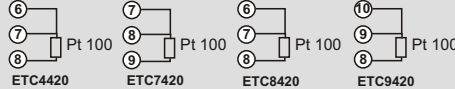

Logic output of the instrument is not electrically insulated from the internal circuits. Therefore, when using a grounding thermocouple, do not connect the logic output terminals to the ground.

- Note:
- 1) Mains supply cords shall meet the requirements of IEC 60227 or IEC 60245.
 - 2) In accordance with the safety regulation, the power supply switch shall bring the identification of the relevant instrument and it should be easily accessible by the operator.

ALARM1 AND ALARM2 OUTPUT TYPES

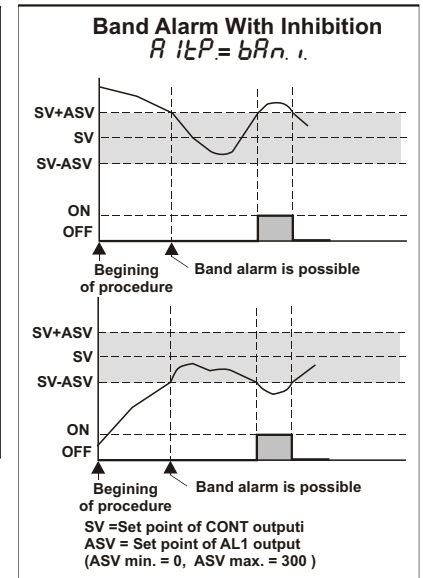
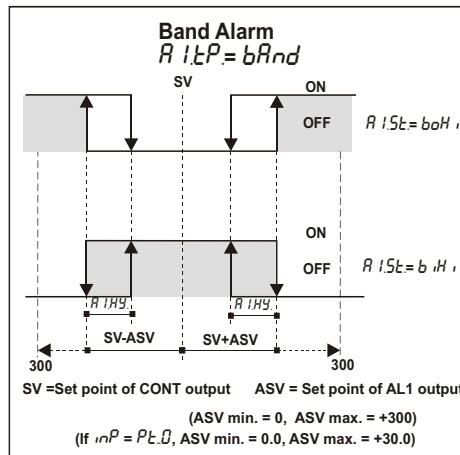
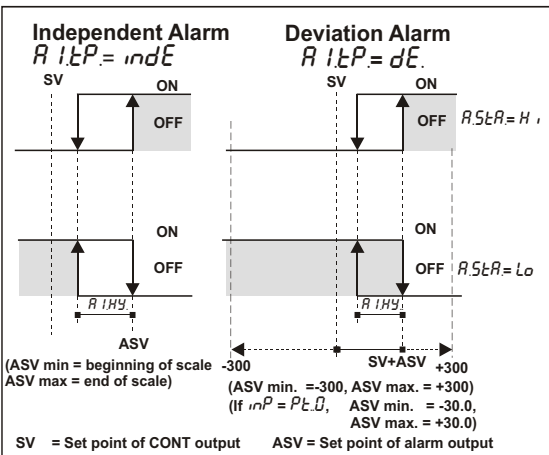

MODIFICATION OF CONTROL AND ALARM SET POINTS

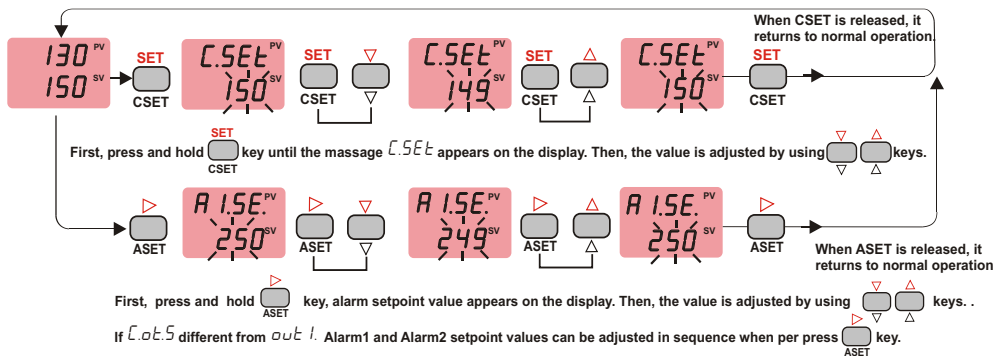

NOTE: The maximum of **C.5Et** is the value of **C.H.iL** parameter and the minimum of it is the value of **C.Lo.L** parameter.
If independent alarm is selected, **R.1SE** and **R.2SE** values can be adjusted between the limits of the full scale.
If deviation alarm is selected, **R.1SE** and **R.2SE** values can be adjusted between -300 and +300.
If band alarm is selected, **R.1SE** and **R.2SE** values can be adjusted between 0 and +300.

Error Messages

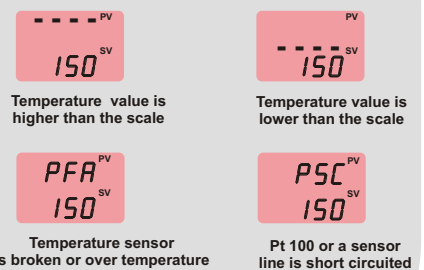

DIMENSIONS

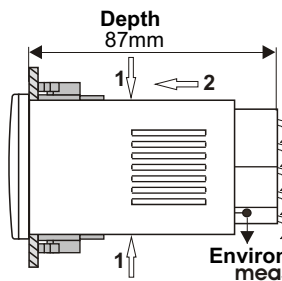
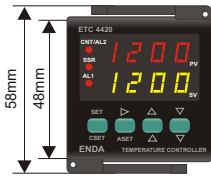

For removing the device from the panel:
- While pressing both side of the device in direction 1, push it in direction 2.

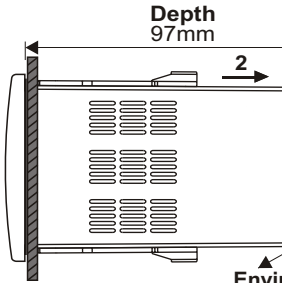
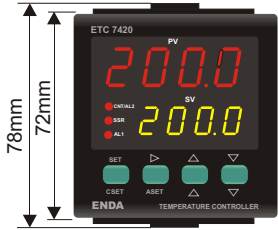
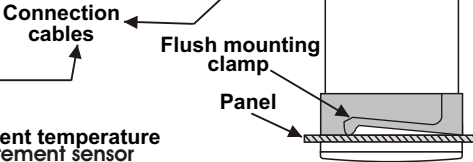

For removing the device from the panel:
-While pressing both side of the device in direction 1, push it in direction 2.

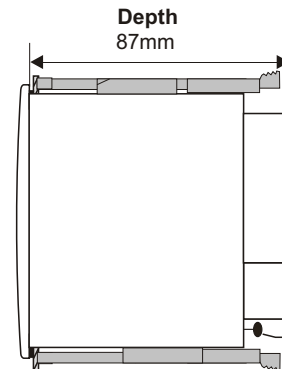
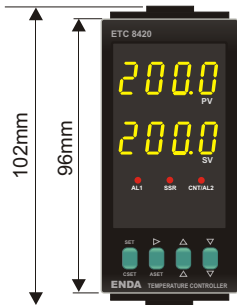
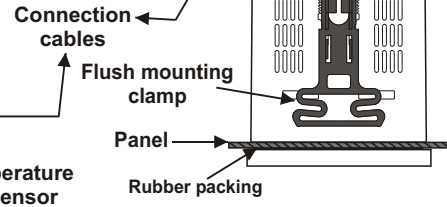

For removing the device from the panel:
-While pressing both side of the device in direction 1, push it in direction 2.

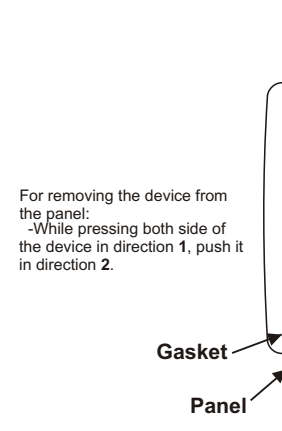
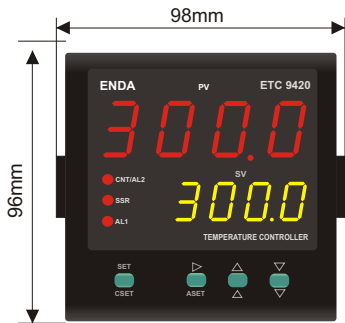
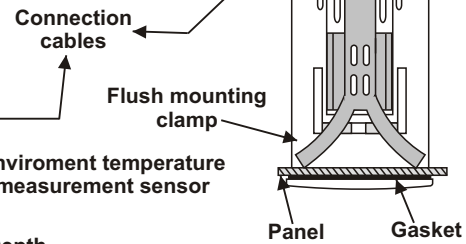

For removing the device from the panel:
-While pressing both side of the device in direction 1, push it in direction 2.

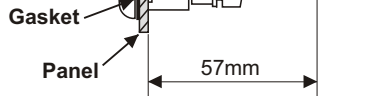

Panel cut-out:

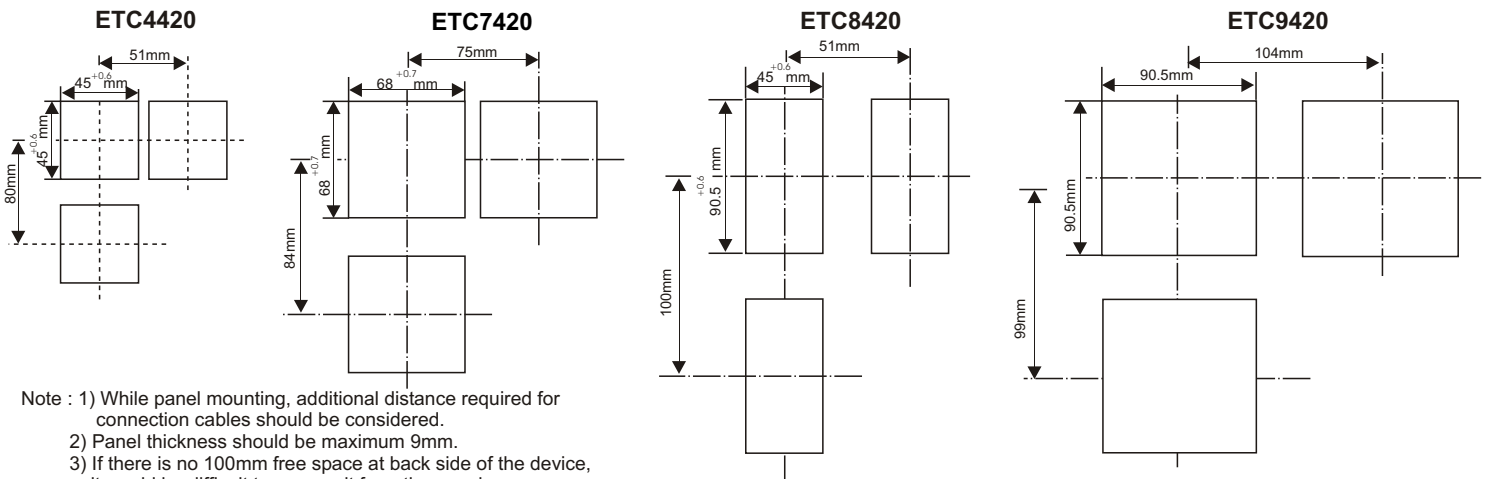

- Note : 1) While panel mounting, additional distance required for connection cables should be considered.
2) Panel thickness should be maximum 9mm.
3) If there is no 100mm free space at back side of the device, it would be difficult to remove it from the panel.