

MODELS 533, 534, 535

3-turn 533 500 to 20KΩ 5-turn 535 500 to 50KΩ 10-turn 534 1000 to 100KΩ

- 3/4-INCH LENGTH ■ HIGH POWER RATING ■ 2-GANG UNIT AVAILABLE AS STANDARD
- RUGGED INTEGRATED CONSTRUCTION ■ EXTRA-TAP OPTIONS ■ SUPERIOR STOP STRENGTH

ACTUAL SIZE

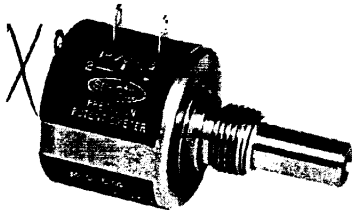

**Models 533, 534, 535
Bushing Mount
Single Section**

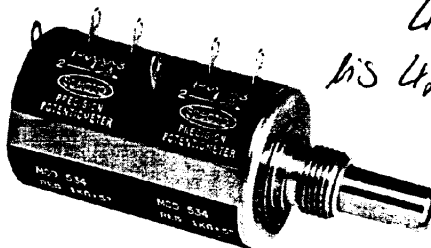

**Models 533, 534, 535
Bushing Mount
Two Section**

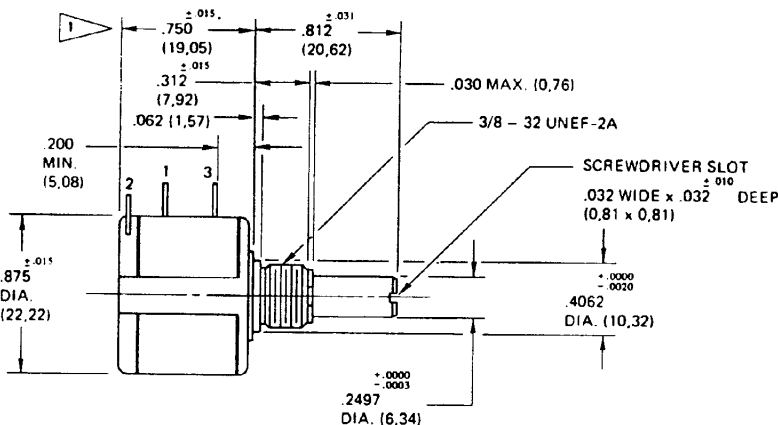

BUSHING MOUNT

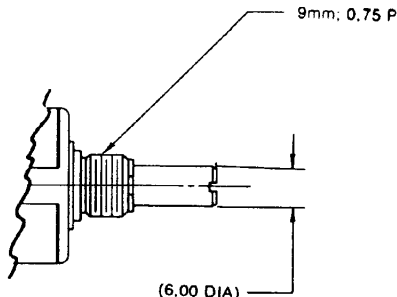
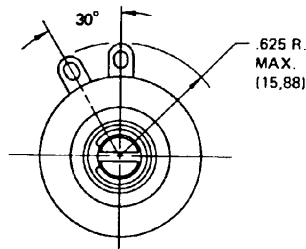

METRIC SHAFT/BUSHING THREAD

TOLERANCES: UNLESS OTHERWISE NOTED.
DECIMALS ±.005 ANGLES ±2°
BASIC DIMENSIONS ARE IN INCHES
MILLIMETER DIMENSIONS IN PARENTHESES

▲ ADD .695 (17.65) FOR 2 SECTION UNIT

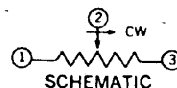

SPECIFICATIONS (Unless otherwise noted, specifications are applicable to all models)

ELECTRICAL

TOTAL RESISTANCE	MODEL 533	Range (ohms) 5 to 60K Standard values (ohms) 50 to 20 K Standard tolerance: ±5% Special to: ±2%
	MODEL 534	Range (ohms) 10 to 200K Standard values (ohms) 100 to 100K Standard tolerance: ±5% Special to: ±1%
	MODEL 535	Range (ohms) 5 to 100K Standard values (ohms) 50 to 50K Standard tolerance: ±5% Special to: ±2%

LINEARITY (INDEPENDENT)	±0.25%	
NOISE	100 ohms ENR	
ROTATION	MODEL 533	1080° ± 10° - 0°
	MODEL 534	3600° ± 10° - 0°
	MODEL 535	1800° ± 10° - 0°
POWER RATING (@ 70°C)	MODEL 533	1.0 watt
	MODEL 534	2.0 watts
	MODEL 535	1.5 watts

INSULATION RESISTANCE	All units derated to zero at 125°C Additional sections: 75% of section 1	
DIELECTRIC STRENGTH	1000 megohms min., 500 vdc	
ABSOLUTE MIN. RESISTANCE	1000 volts rms min., 60 Hz Not to exceed linearity x total resistance or 1Ω, whichever is greater	
TEMPCO	20 PPM/°C (standard values, wire only)	
END VOLTAGE	0.25% of total applied voltage, maximum	
PHASING	CCW end points—section 2 phased to section 1 within ±2°	
TAPS	Center tap only	

MARKING

Units shall be marked with Spectrol name and model No., resistance and tolerance, linearity, terminal identification and date code

MECHANICAL

ROTATION	MODEL 533	1080° ± 10° - 0°
	MODEL 534	3600° ± 10° - 0°
	MODEL 535	1800° ± 10° - 0°

MECHANICAL (Cont.)

BEARING TYPE	Bushing: sleeve bearing	
TORQUE (MAXIMUMS)	Starting	
(BUSHING AND SERVO MOUNT)	534	533, 535
0.2 IN. (GM CM)	1 Section	0.5 (36) 0.7 (50)
	2 Section	0.9 (65) 1.1 (79)
MECHANICAL RUNOUTS (MAXIMUMS)	Bushing	
	Shaft runout (TIR/IN)	0.03 (0.08)
	Pilot dia runout (TIR)	0.03 (0.08)
	Lateral runout (TIR)	0.05 (0.13)
	Shaft end play	0.10 (0.25)
	Shaft radial play	0.03 (0.08)
WEIGHT (MAXIMUMS)	1 Section	0.75 oz (21.26 gm)
	2 Section	1.25 oz (35.44 gm)
STOP STRENGTH	75 oz-in. (static) (5.4 Kgm cm)	
GANGING	2 sections maximum	

ENVIRONMENTAL

VIBRATION	15g thru 2000 Hz		
SHOCK	50g		
ROTATIONAL LIFE (SHAFT REVOLUTIONS)	533	534	535
	300,000	1,000,000	500,000
LOAD LIFE	900 hours		
TEMPERATURE RANGE	-55°C to +125°C		
MOISTURE RESISTANT			
SALT SPRAY	96 hours		

MATERIALS

FRONT LID	Stainless steel, nickel plated brass (bushing)
HOUSING	Molded glass filled thermoset plastic
REAR LID	Molded glass filled thermoplastic
SHAFT	Stainless steel, non magnetic, passivated
TERMINALS	Brass, plated for solderability
MOUNTING HARDWARE	Lockwasher: internal tooth, steel, nickel plated Panel nut: brass, nickel plated

POWER RATING CHART

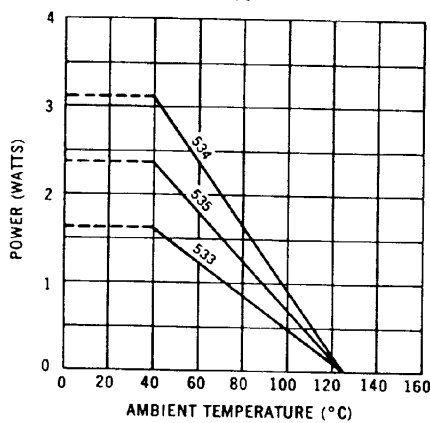

RESISTANCE ELEMENT DATA

RESISTANCE VALUES (OHMS)			RESOLUTION %			OHMS PER TURN			MAX CURRENT AT 70°C AMBIENT (MILLIAMPS)			MAX VOLTAGE ACROSS COIL (VOLTS)		
533	534	535	533	534	535	533	534	535	533	534	535	533	534	535
50	-	50	.149	-	.120	.0746	-	.0603	141.0	-	173.0	7.07	-	8.66
100	100	100	.111	.060	.075	.1114	.0603	0746	100.0	141.0	122.0	10.0	14.1	12.2
200	200	200	.097	.037	.061	.1954	.0746	1220	70.7	100.0	86.6	14.1	20.0	17.3
500	500	500	.069	.031	.049	.3424	.1520	2459	44.7	63.2	54.7	22.4	31.6	27.4
1K	1K	1K	.063	.025	.041	.6331	2459	4113	31.6	44.7	38.7	31.6	44.7	38.7
2K	2K	2K	.041	.021	.031	.8206	4113	6331	22.4	31.6	27.4	44.7	63.2	54.8
5K	5K	5K	.044	.016	.034	2.2330	8206	17230	14.1	20.0	17.3	70.7	100.0	86.6
10K	10K	10K	.034	.017	.030	3.4510	17230	30160	10.0	14.1	12.2	100.0	141.0	122.0
20K	20K	20K	.031	.015	.020	6.1790	30160	39910	7.07	10.0	8.66	141.0	200.0	173.0
-	50K	50K	-	.009	.015	-	4.6690	7.4560	-	6.32	5.47	-	316.0	274.0
-	100K	100K	-	.007	-	-	7.4560	-	-	4.47	-	-	447.0	-
-	-	-	-	-	-	-	-	-	-	-	-	-	-	-
-	-	-	-	-	-	-	-	-	-	-	-	-	-	-

HOW TO ORDER THE MODEL 533, 534, OR 535

Models can be ordered from this specification sheet by stating:

1. Model 533, 534, or 535.
2. Mounting type (bushing or Metric Shaft/thread).
3. The total resistance of each section, beginning with the section nearest the mounting end.
4. The number of sections desired.

Example: Model 534, Metric Shaft/thread, 10K, single section.
Example: Model 533, bushing, 10K/100K, 2 section.
Example: Model 534, bushing, 100K, single section.
Example: Model 535, bushing, 20K, single section.

Except where otherwise noted, all characteristics described on this sheet are standard. If special characteristics are required, please state these on your order. Some of the special features that can be provided are: extra taps, special linearity tolerance, special resistance tolerance, non-linear functions, plastic shaft or combination metal-plastic shaft, rear shaft extension, dual concentric shafts, high shaft torque, special shaft diameters, mounting configurations, non-turn pin, sealed units for high humidity applications, and 1/4 dia. shaft with 1/4-32 bushing thread.



Spectrol Electronics
 17070 E. Gale Avenue
 City of Industry, CA 91745, U.S.A.
 (818) 964-6565 • TWX (910) 584-1314
 FAX 818/810-1093

Spectrol Reliance Ltd.
 Drakes Way
 Swindon, Wiltshire, England
 Swindon 21351 • TELEX: 44692
 FAX 011-44-793-39255

SP Elettronica spa
 Via Monti, 23
 200 16 Pero (Milan) Italy
 35 30 241 • TELEX: 330091
 FAX 011-39-2-35-34-639

5.6 □ TERMINAL BASED LINEARITY (WIREWOUND POTENTIOMETERS ONLY) The maximum deviation, expressed as a percent of the Total Applied Voltage, of the actual function characteristic from a straight reference line drawn through the specified minimum and maximum Output Ratios which are separated by the Actual Electrical Travel. Unless otherwise specified, minimum and maximum Output Ratios are, respectively, zero and 100% of Total Applied Voltage.

MATHEMATICALLY: $\frac{e}{E} = A(\theta/\theta_A) + B \pm C$

Where:

A is given slope; B is given intercept at $\theta = 0$.

Unless otherwise specified:

A = 1; B = 0.

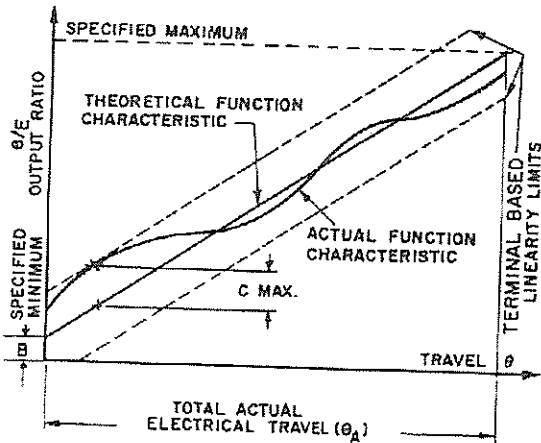

FIGURE 5.6 Terminal based linearity — wirewound

5.7 □ ZERO BASED LINEARITY (WIREWOUND POTENTIOMETERS ONLY) The maximum deviation, expressed as a percent of Total Applied Voltage, of the actual function characteristic from a straight reference line drawn through the specified minimum Output Ratio, extended over the Actual Electrical Travel, with its slope chosen to minimize the maximum deviations. Any specified End Voltage requirement may limit the slope of the reference line. Unless otherwise specified, the specified minimum Output Ratio will be zero.

MATHEMATICALLY: $\frac{e}{E} = P(\theta/\theta_A) + B \pm C$

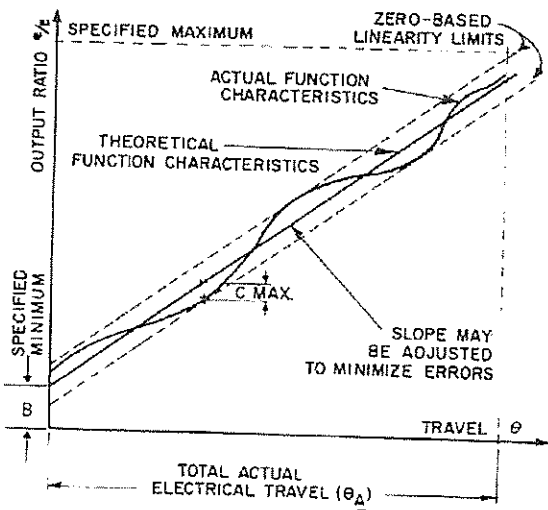

FIGURE 5.7 Zero based linearity — wirewound

Where:

P is unspecified slope limited by the End Voltage requirements, at the maximum output ratio end.

Unless otherwise specified:

B = 0.

5.8 □ INDEPENDENT LINEARITY (BEST STRAIGHT LINE)

5.8.1 □ INDEPENDENT LINEARITY — WIREWOUND The maximum deviation, expressed as a percent of the Total Applied Voltage, of the actual function characteristic from a straight reference line with its slope and position chosen to minimize deviations over the Actual Electrical Travel, or any specified portion thereof.

Note: End Voltage requirements, when specified, will limit the slope and position of the reference line.

MATHEMATICALLY: $\frac{e}{E} = P(\theta/\theta_A) + Q \pm C$

Where:

P is unspecified slope; Q is unspecified intercept at $\theta = 0$. And both are chosen to minimize C but are limited by the End Voltage requirements.

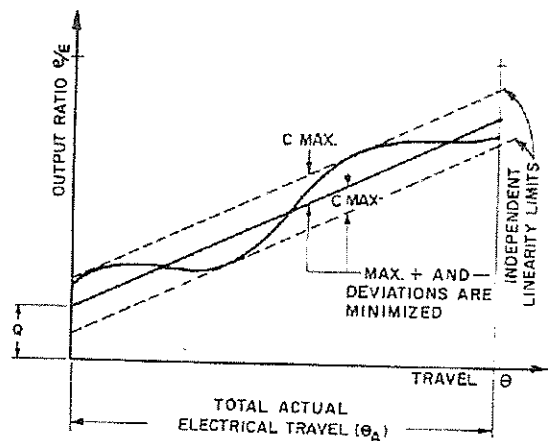

FIGURE 5.8.1 Independent linearity — wirewound

5.8.2 □ INDEPENDENT LINEARITY — NONWIREWOUND The maximum deviation of the actual function characteristics from a straight reference line with its slope and position chosen to minimize the maximum deviations. It is expressed as a percentage of the Total Applied Voltage and is measured over the specified Theoretical Electrical Travel. The slope of the reference line, if limited, must be separately specified. An

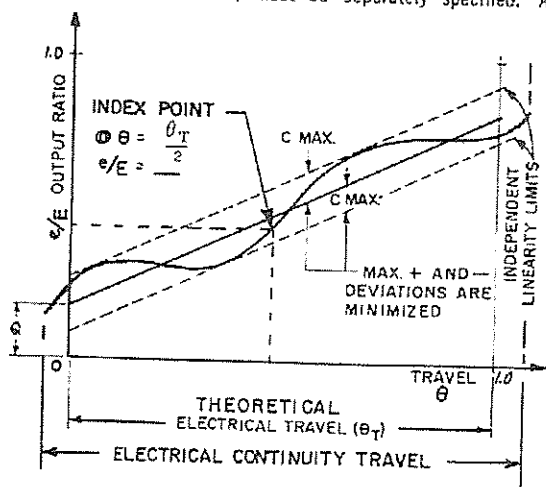

FIGURE 5.8.2 Independent linearity — nonwirewound