

NOTE: 1.If no note,all resistors used 1/4W

Title		
EA-BC-512-21-RT		
Size	Number	Revision
A3		
Date:	9.May.2003	Sheet of
File:	D:\Engineer\300W.Dxb	Drawn By:

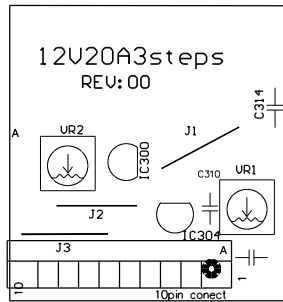

MEC		FILE NAME: 12V20A3steps	
NAME:	Top Silkscreen	CHECK:	
SCALE:	2 : 1	DRAW:	Chen YW
UNITS:	mm	DATE:	9-May-2003
TOLERANCE:	+0,1mm	SHEET:	1 / 1
MATERIAL:	FR3 1.6mm Cu: 35um	REV. :	00

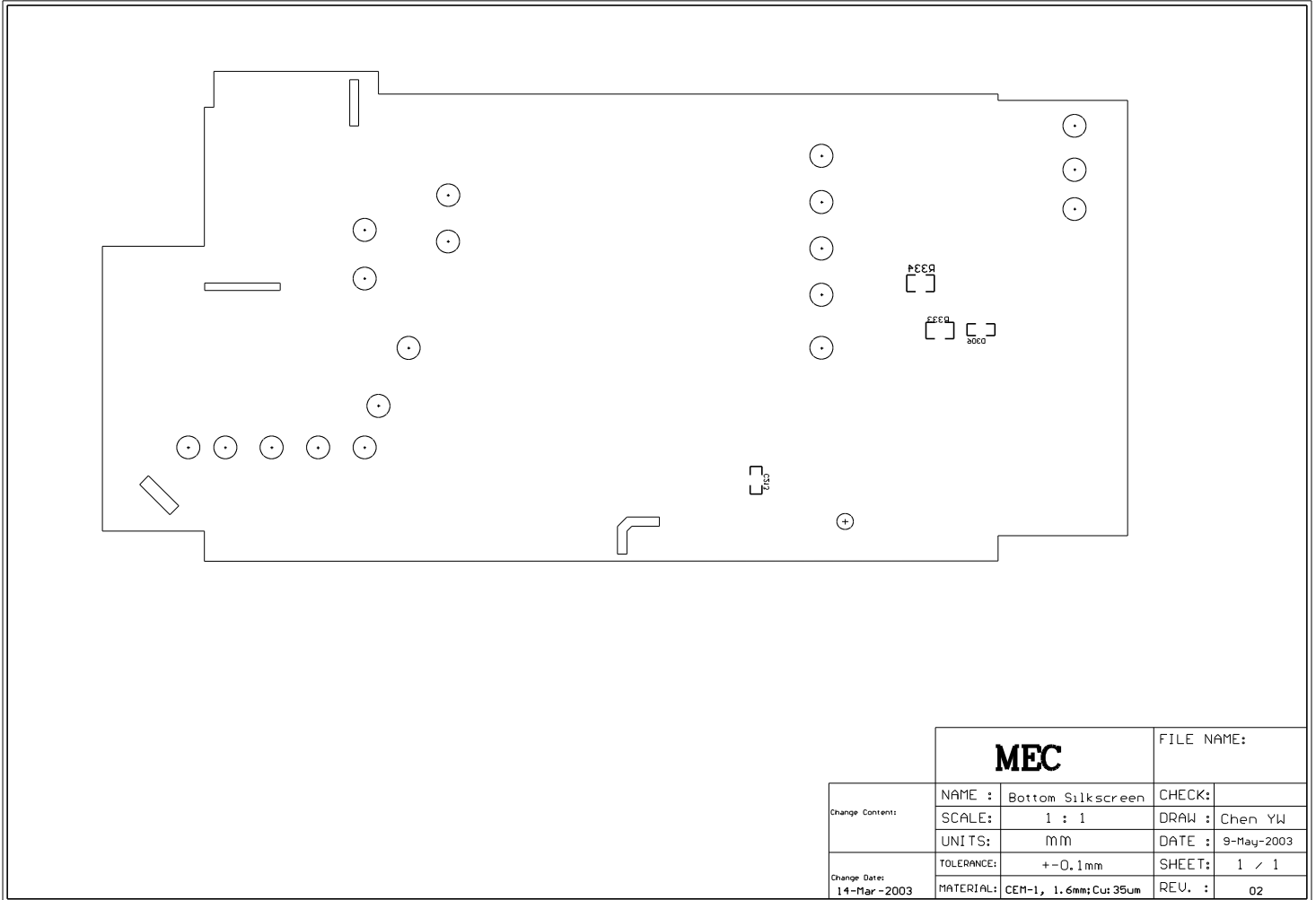

	<b>MEC</b>		FILE NAME:
Change Content:	NAME : Bottom Silkscreen	CHECK:	
	SCALE: 1 : 1	DRAW :	Chen YW
	UNITS: mm	DATE :	9-May-2003
Change Date:	TOLERANCE: $\pm 0.1$ mm	SHEET:	1 / 1
14-Mar-2003	MATERIAL: CEM-1, 1.6mm; Cu: 35um	REV. :	02

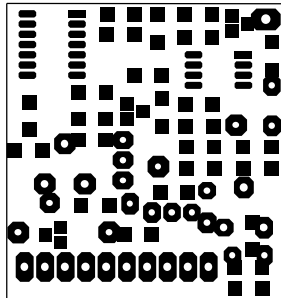

<b>MEC</b>		FILE NAME: 12U20A3steps	
NAME:	Bottom Solder Mask	CHECK:	
SCALE:	2 : 1	DRAW:	Chen YW
UNITS:	mm	DATE:	9-May-2003
TOLERANCE:	+0,1mm	SHEET:	1 / 1
MATERIAL:	FR3 1.6mmCu:35um	REV. :	00

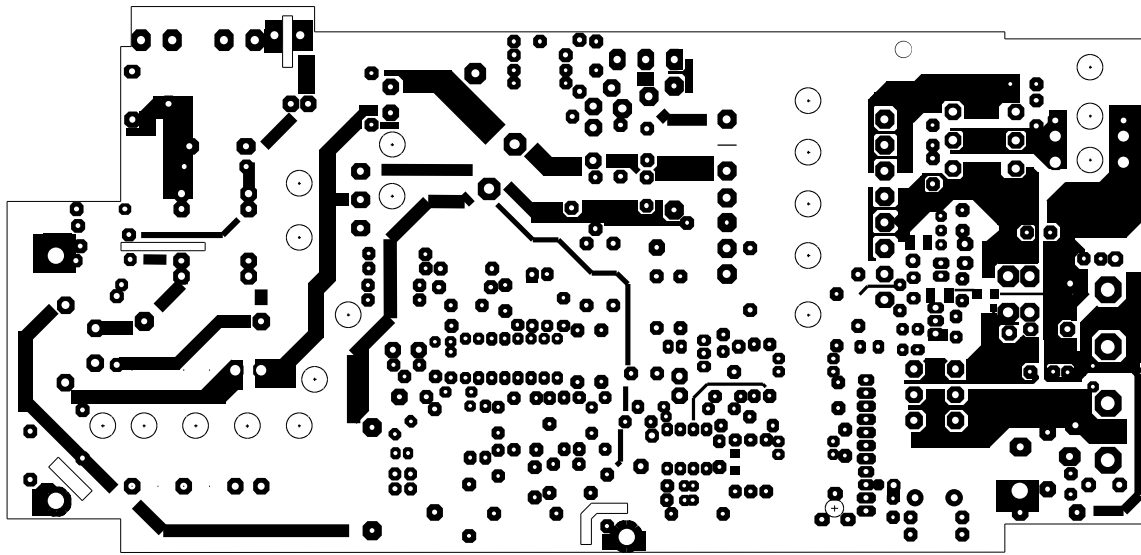

		<b>MEC</b>	FILE NAME:
Change Content:	NAME :	Bottom Solder Mask	CHECK:
	SCALE:	1 : 1	DRAW : Chen YW
	UNITS:	mm	DATE : 9-May-2003
Change Date: 14-Mar-2003	TOLERANCE:	+ -0.1mm	SHEET: 1 / 1
	MATERIAL:	CEM-1, 1.6mm; Cu: 35um	REV. : 02

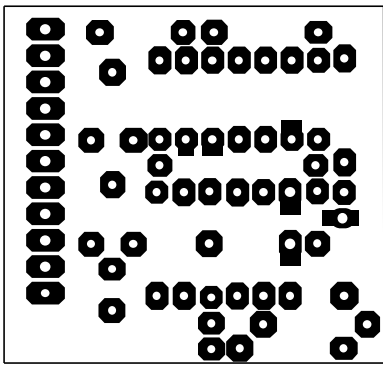

Change Date:  2003-Mar -14	<b>MEC</b>		FILE NAME: CONTROL PCB	
	NAME:	Bottom Solder Mask	CHECK:	
	SCALE:	2 : 1	DRAW:	Chen YW
	UNITS:	mm	DATE:	9-May-2003
	TOLERANCE:	+ - 0.1mm	SHEET:	1 / 1
MATERIAL:	CEN-1 1.6mm Cu: 35um	REV. :	<b>01</b>	

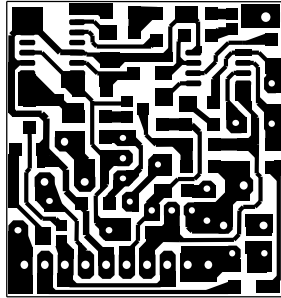

MEC		FILE NAME: 12U20A3steps	
NAME:	Bottom Copper	CHECK:	
SCALE:	2 : 1	DRAW:	Chen YW
UNITS:	mm	DATE:	9-May-2003
TOLERANCE:	+0.1mm	SHEET:	1 / 1
MATERIAL:	FR3 1.6mm Cu: 35um	REV. :	00

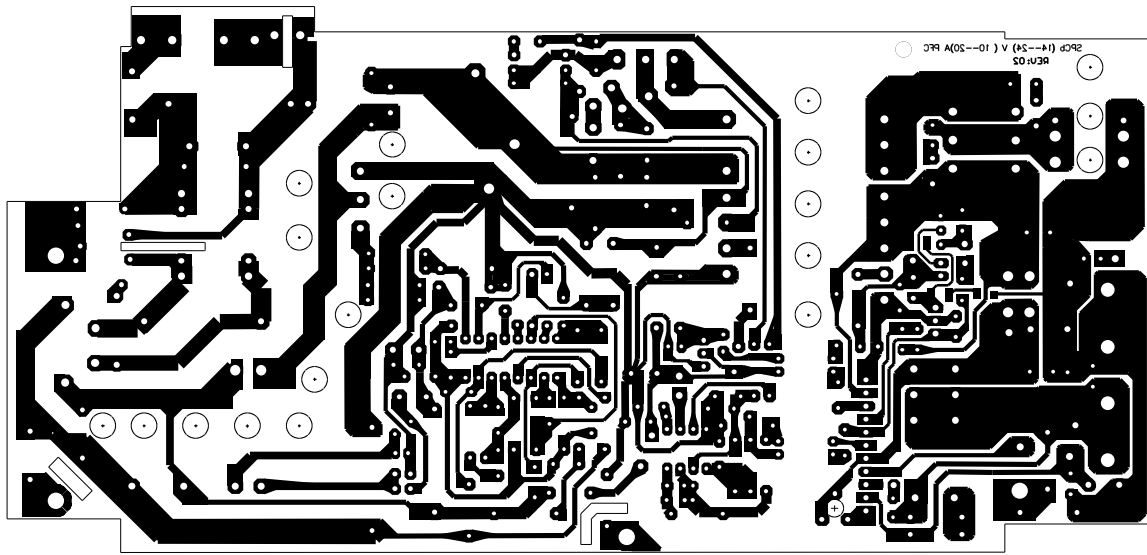

		<b>MEC</b>		FILE NAME:	
Change Content:	NAME :	Bottom Copper	CHECK:		
	SCALE:	1 : 1	DRAW :	Chen YW	
	UNITS:	mm	DATE :	9-May-2003	
Change Date: 14-Mar-2003	TOLERANCE:	+ -0.1mm	SHEET:	1 / 1	
	MATERIAL:	CEM-1, 1.6mm; Cu: 35um	REV. :	02	



Job: Use old mold use (CONTROL PCB)

REV: 00

1. Change copper
2. Add hole3 PCS (3x1mm)
3. Charge Bottom Solder

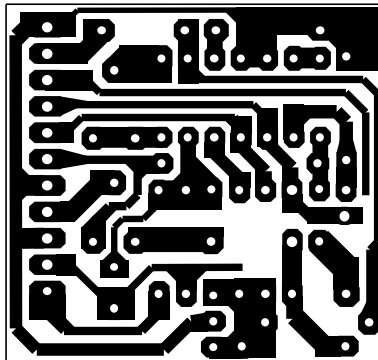

	<b>MEC</b>		FILE NAME: CONTROL PCB
Change Date:	NAME:		CHECK:
	SCALE:	2 : 1	DRAW: Chen YW
2003-Mar -14	UNITS:	mm	DATE: 9-May-2003
	TOLERANCE:	+ - 0.1mm	SHEET: 1 / 1
	MATERIAL:	CEN-1 1.6mm Cu: 35um	REV. : 01



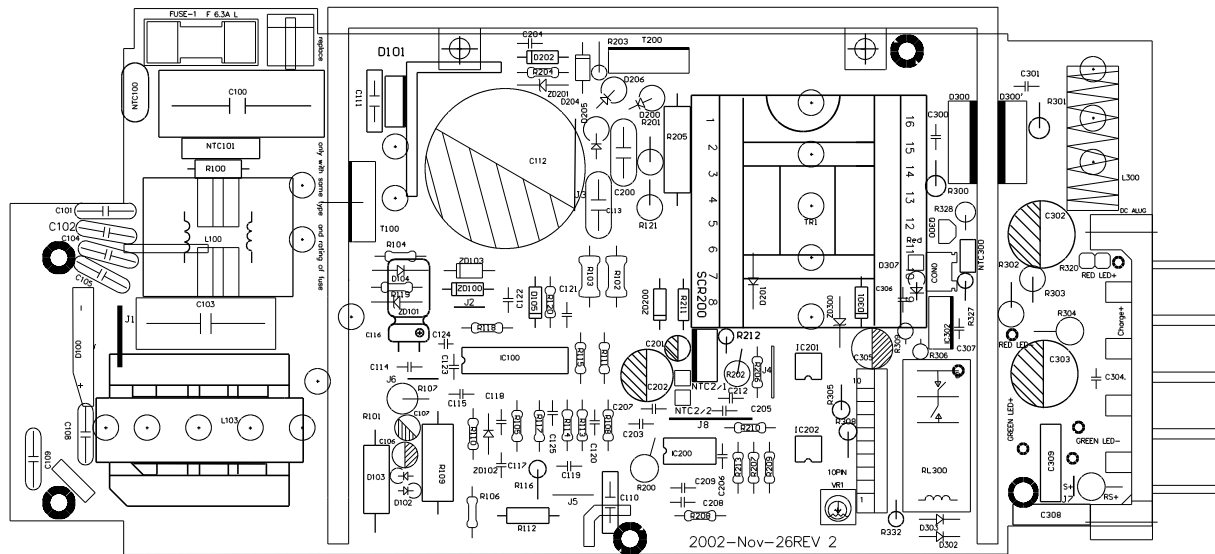

<b>MEC</b>		FILE NAME:
Change Content:	NAME : Top Silkscreen	CHECK:
	SCALE: 1 : 1	DRAW : Chen YW
Change Date: 14-Mar-2003	UNITS: mm	DATE : 9-May-2003
	TOLERANCE: +/-0.1mm	SHEET: 1 / 1
	MATERIAL: CEM-1, 1.6mm; Cu: 35um	REV. : 02

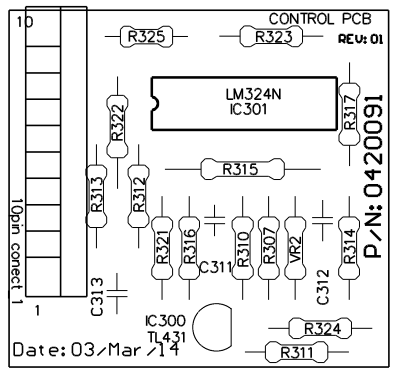

Change Date:	<b>MEC</b>		FILE NAME:	
			CONTROL PCB	
	NAME:	Top Silkscreen	CHECK:	
	SCALE:	2 : 1	DRAW:	Chen YW
2003-Mar-14	UNITS:	mm	DATE:	9-May-2003
	TOLERANCE:	+ - 0.1mm	SHEET:	1 / 1
	MATERIAL:	CEN-1 1.6mm Cu: 35um	REV. :	01