

ANTI-VANDAL PUSHBUTTONS

PUSH BUTTON SWITCH



GQ19-B

- ⊙ Φ 19mm diameter
- ⊙ 2A/48VDC
- ⊙ 1NO
- ⊙ The Front Shape:Domed
- ⊙ The crust material:Stainless Steel/
Brass(Nikel Plated,Gold Plated)
- ⊙ IP Degree:IP65

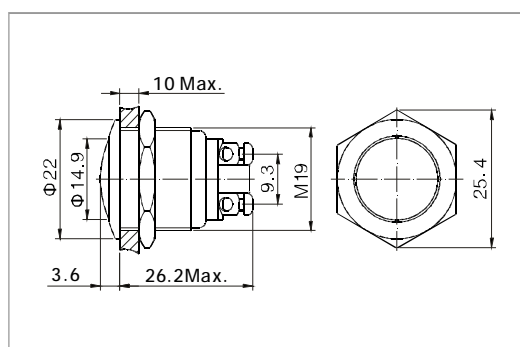

PUSH BUTTON SWITCH



GQ19-F

- ⊙ Φ 19mm diameter
- ⊙ 2A/48VDC
- ⊙ 1NO
- ⊙ The Front Shape:Flat Round
- ⊙ The crust material:Stainless Steel/
Brass(Nikel Plated,Gold Plated)
- ⊙ IP Degree:IP65

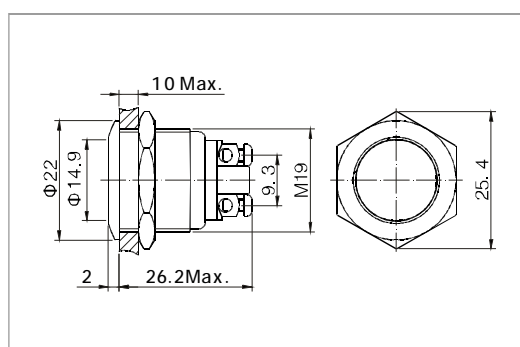

PUSH BUTTON SWITCH



GQ19-H

- ⊙ Φ 19mm diameter
- ⊙ 2A/48VDC
- ⊙ 1NO
- ⊙ The Front Shape:High Round
- ⊙ The crust material:Stainless Steel/
Brass(Nikel Plated, Gold Plated)
- ⊙ IP Degree:IP65

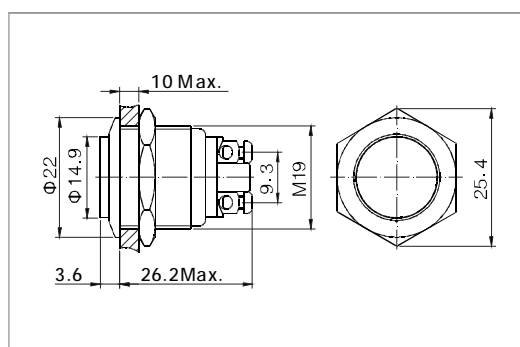

Specification	GQ19-B	GQ19-F	GQ19-H
The Front Shape	Domed	Flat Round	High Round
Terminal Type	Screw Terminals	Screw Terminals	Screw Terminals
Switching	No.1	No.1	No.1
Max.Switch Rating	2A/48VDC	2A/48VDC	2A/48VDC
Contact Resistance	$\leq 50m\Omega$	$\leq 50m\Omega$	$\leq 50m\Omega$
Insulation Resistance	$\geq 1000M\Omega$	$\geq 1000M\Omega$	$\geq 1000M\Omega$
Dielectric Strength	2000VAC	2000VAC	2000VAC
Operation Temp.	-20°C ~ +70°C	-20°C ~ +70°C	- 20°C ~ + 70°C
Mechanical Life	1,000,000cycles	1,000,000cycles	1,000,000cycles
Electrical Life	200,000cycles	200,000cycles	200,000cycles
Contact Material	Silver Alloy	Silver Alloy	Silver Alloy
Panel Thickness	1 ~ 8mm	1 ~ 8mm	1 ~ 8mm
Torque	5 ~ 14Nm	5 ~ 14Nm	5 ~ 14Nm
Operation Temp.	5.5N	5.5N	5.5N
IP Degree	IP65	IP65	IP65
Material	Button	Stainless Steel/Brass(Nikel Plated,Gold Plated)	Stainless Steel/Brass(Nikel Plated,Gold Plated)
	Body	Stainless Steel/Brass(Nikel Plated,Gold Plated)	Stainless Steel/Brass(Nikel Plated,Gold Plated)
	Base	PBT	PBT
RoHS	Made to order	Made to order	Made to order