



Frontabmessung: 28 x 28 mm
Einbauöffnung: Ø 22 mm
Frontrahmenhöhe: 2 mm
Hub: 3 mm



RONTRON-Q-JUWEL

Übersicht / Hülsenfarben / Symbolerklärung Baureihe RONTRON-Q-JUWEL



- | | |
|-------------------------------------|-----------|
| 01 Drucktasten | Seite 179 |
| 02 Not-Aus-Tasten / Not-Halt-Tasten | Seite 180 |
| 03 Wahltasten | Seite 180 |
| 04 Schlüsseltasten | Seite 182 |
| 05 Akustische Signalgeber | Seite 185 |
| 06 Leuchtensvorsatz / Meldeleuchten | Seite 186 |



IP65 Schutzart

 beleuchtbar

3mm Betätigungshub

 beschriftbar



Einbautiefenmaße

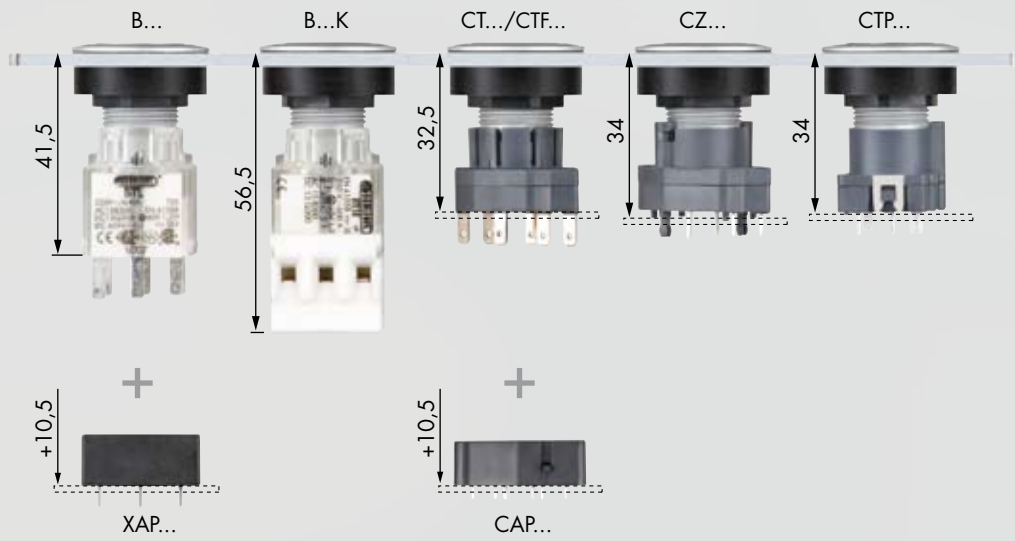

Maße Einbauöffnung

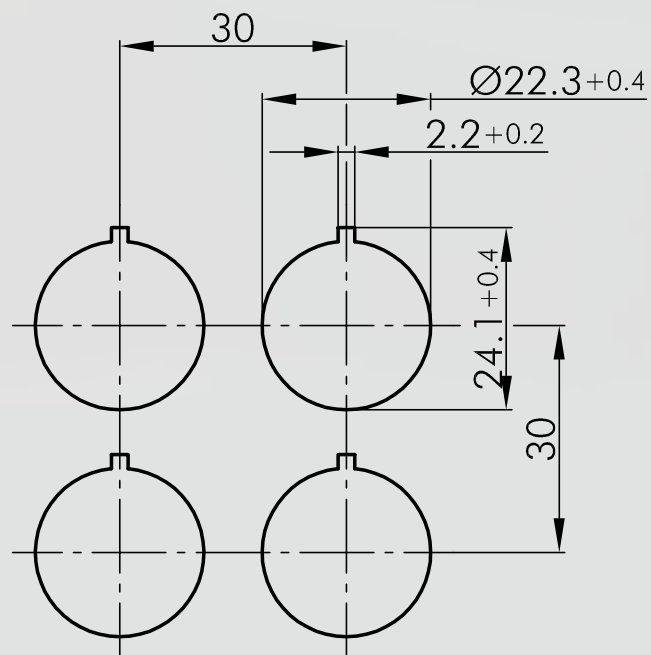

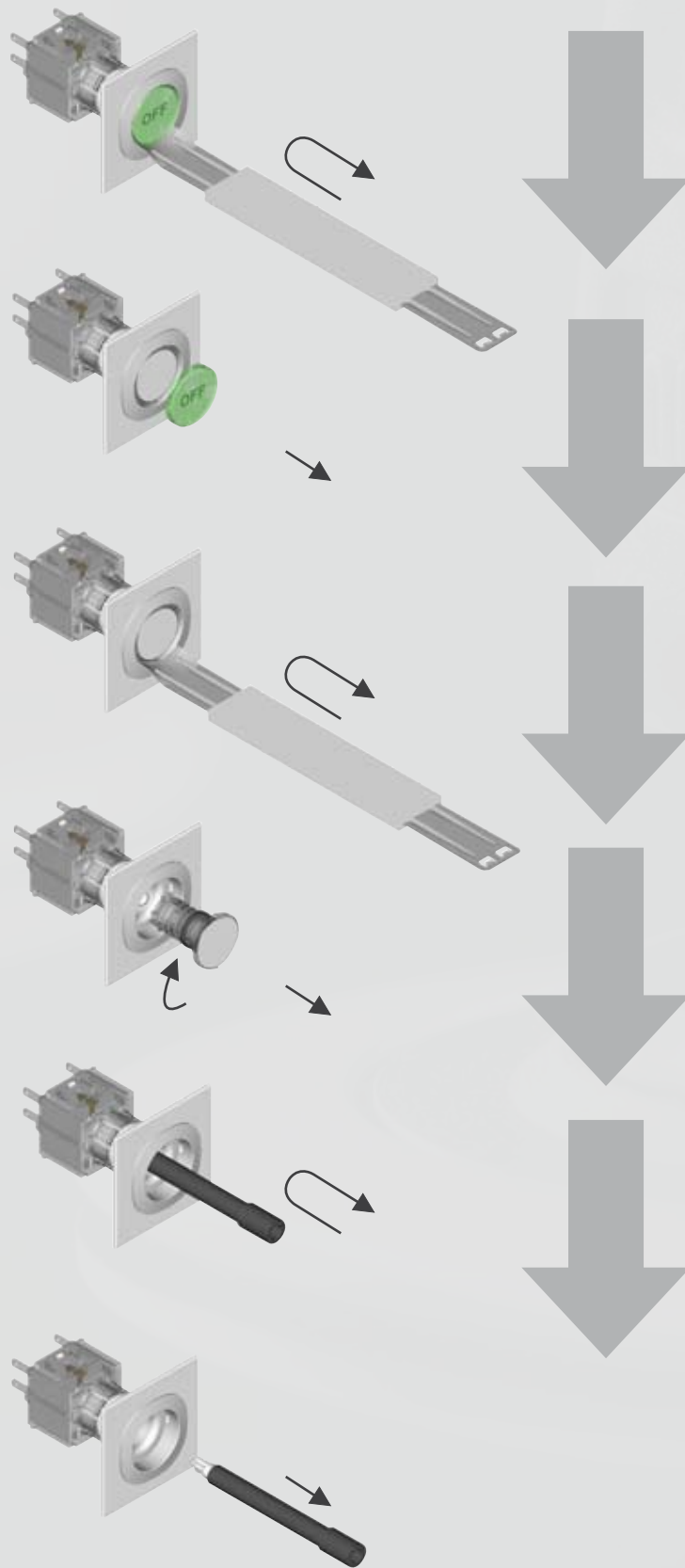

	RQJL4	RQJN	RQJNSG+SG-24V	RQJNSG+SGI-24V	RQJSSA12	RQJSSA13	RQJSSA14	RQJSSA15	RQJSSA16	RQJSSA17	RQJSSA18	RQJSSA23	RQJSSA25	RQJSSA28	RQJSSA31	RQJSTA	RQJSTAL...	RQJSTB	RQJSTBL...	RQJTB	RQJTLR	RQJWA	RQJWAL...	RQJWB	RQJWBL...	RQJWC	RQJWCL...
ASI_BZ					●	●	●	●	●	●	●	●	●	●	●	●					●	●	●	●	●	●	●
ASI_BZL5	●																●		●				●		●		●
BF(K)																						●					
BFI(K)																						●					
BFL(K)																						●	●				
BFL5(K)																						●	●	●			
BFL5_439																						●	●	●			
BFLI(K)																						●	●	●			
BFLI5(K)																						●	●	●			
BFL_439																						●	●	●			
BF_439																						●	●	●			
BL4(K) / BL5(K)	●																										
BT(K)						●	●	●	●	●	●		●		●							●					
BTI(K)						●	●	●	●	●	●		●		●							●					
BTL(K)																	●					●					
BTL5(K)																	●					●					
BTL5_439																	●					●					
BTLI(K)																	●					●					
BTLI5(K)																	●					●					
BTLO(K)																	●					●					
BTLO5(K)																	●					●					
BTL_439																	●					●					
BTO(K)						●	●	●	●	●	●		●		●							●					
BT_439						●	●	●	●	●	●		●		●							●					
BZl(K)						●	●	●	●	●	●		●		●							●					
BZII(K)					●	●	●	●	●	●	●	●	●	●	●	●		●				●		●		●	
BZLI(K)																	●					●					
BZLI5(K)																	●					●					
BZLII(K)																	●		●			●		●		●	
BZLII5(K)																	●		●			●		●		●	
BZLO(K)																	●					●					
BZLO5(K)																	●					●					
BZLOI(K)																	●		●			●				●	●
BZLOI5(K)																	●		●			●			●	●	●
BZLOO(K)																	●		●			●			●	●	●
BZLOO5(K)																	●		●			●			●	●	●
BZL_439																	●		●			●			●	●	●
BZO(K)						●	●	●	●	●	●	●	●	●	●	●		●				●		●		●	
BZOI(K)					●	●	●	●	●	●	●	●	●	●	●	●		●				●		●		●	
BZOO(K)					●	●	●	●	●	●	●	●	●	●	●	●		●				●		●		●	
BZ_439					●	●						●	●	●	●			●				●		●		●	
CL		●																									
CLP_485		●																									
CT						●	●	●	●	●	●		●		●							●		●			
CT2					●	●	●	●	●	●	●	●	●	●	●	●		●				●		●		●	
CTF						●	●	●	●	●	●		●		●							●					
CTL																	●					●					
CTL2																	●		●			●		●		●	●
CTLF																	●					●					
CTLP_485																	●					●		●			
CTP_485						●	●	●	●	●	●		●		●							●					
CZLP		●																									
CZTLP																	●					●		●			
CZTLP2																	●		●			●		●		●	●
CZTP						●	●	●	●	●	●		●		●							●		●			
CZTP2					●	●	●	●	●	●	●	●	●	●	●	●		●				●		●		●	
L4		●																									

Drucktaste (tastend/schaltend)

Tasterkappen/Kalotten und Bezeichnungsschilder bitte extra bestellen

Abbildung	Abmessung	Beschreibung	Type
  	<p>Drucktaste</p>  <p>C US</p> <p>Frontrahmen metallisch</p>	RQJT	
	<p>Tasterkappe, flach, transparent</p> <p>Farben: BL-blau, GB-gelb, GN-grün, KL-glasklar, RT-rot, WS-opalweiß Kurzbezeichnung an die Type anhängen, z. B. T22RRBL</p>	T22RR...	
	<p>Tasterkappe, flach, gedeckt</p> <p>Ausführung für unbeschriftete Tasten (nicht beleuchtbar). Farben: BL-blau, GB-gelb, GN-grün, SW-schwarz, RT-rot, WS-weiß Kurzbezeichnung an die Type anhängen, z. B. T22RRGWS</p>	T22RRG...	
	<p>Bezeichnungsschild unbedruckt</p>	BSRRU	
	<p>Bezeichnungsschild</p> <p>mit Standarddruck, bitte Index-Nr. angeben (siehe Bezeichnungsschilder)</p>	BSRR...	
	<p>Bezeichnungsschild</p> <p>mit Sonderdruck nach Kundenangabe</p>	BSRRB	
  	<p>Drucktaste mit Ringbeleuchtung</p> <p>inkl. Tasterkappe, Beschriftung auf Anfrage</p>  <p>C US</p> <p>Frontrahmen metallisch</p>	RQJTLR	

Berührung
 Befehlsgeräte
 Berührung
 Freilaufverbindungen
 Galvanis
 Ein-/Aus
 Ein-/Aus
 Freilaufverbindungen
 Berührung

RONTRON-Q-JUWEL

Ø 22 mm

Not-Halt/Not-Aus-Taste
Potentiometer-Antrieb
Wahltaste (tastend/schaltend)

I = Schaltstellung
 > = Federrückzug

Abbildung

Abmessung

Beschreibung

Type



Weitere Not-Halt/Not-Aus-Tasten finden Sie in der Rubrik „Not-Halt/Not-Aus-Tasten“

Die Not-Halt/Not-Aus-Tasten sind auch mit anderen Pilzknopffarben als verrastbare Pilztasten lieferbar.

IP65

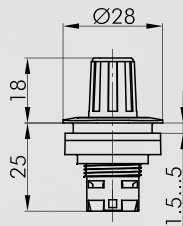

Potentiometer-Antrieb

Mit Drehgriff, jedoch ohne Poti. Für Poti mit 6 mm Achsendurchmesser und Gewinde M10 x 0,75. Achsenlänge: ca. 32 mm

Frontrahmen metallisch

RQJR

IP65

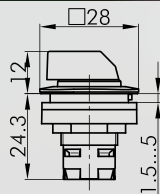

Wahltaste

Frontrahmen metallisch



RQJWA

IP65

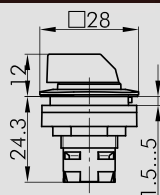

Wahltaste

Frontrahmen metallisch

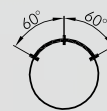

RQJWB

IP65

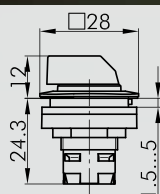

Wahltaste



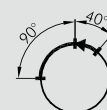







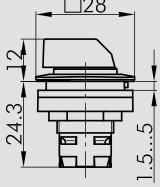

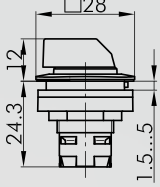
Frontrahmen metallisch

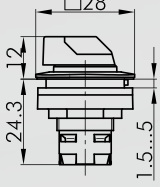

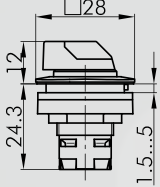
RQJWC

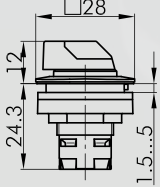
Wahltaste (tastend/schaltend)

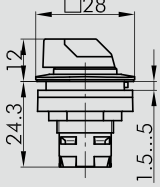
 I = Schaltstellung
 > = Federrückzug

Abbildung	Abmessung	Beschreibung	Type
IP65 		Schwenktaste Frontrahmen metallisch	 RQJSTA
IP65 		Schwenktaste Frontrahmen metallisch	 RQJSTB
IP65 		Leucht-Wahltaste Knebefarben: BL-blau, GB-gelb, KL-glasklar, GN-grün, RT-rot (z.B. RQJWAL_GN) Frontrahmen metallisch	 RQJWAL...
IP65 		Leucht-Wahltaste Knebefarben: BL-blau, GB-gelb, KL-glasklar, GN-grün, RT-rot (z.B. RQJWBL_GN) Frontrahmen metallisch	 RQJWBL...
IP65 		Leucht-Wahltaste Knebefarben: BL-blau, GB-gelb, KL-glasklar, GN-grün, RT-rot (z.B. RQJWCL_GN) Frontrahmen metallisch	 RQJWCL...
IP65 		Leucht-Schwenktaste Knebefarben: BL-blau, GB-gelb, KL-glasklar, GN-grün, RT-rot (z.B. RQJSTAL_GN) Frontrahmen metallisch	 RQJSTAL...

181
 Beleuchtungen
 Relais
 Ein-/Aussteuerung
 Galvanische Trennung
 Befehlsgeräte
 Berührung

RONTRON-Q-JUWEL

Ø 22 mm

Wahltaste (tastend/schaltend)
Schlüsseltaste (tastend/schaltend)

I = Schaltstellung
> = Federrückzug
○ = Schlüsselabzugstellung

Abbildung

Abmessung

Beschreibung

Type

IP65

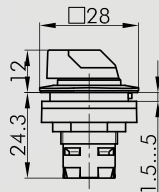

Leucht-Schwenktaste

Knebelfarben: BL-blau, GB-gelb, KL-glasklar, GN-grün, RT-rot (z.B. RQJSTBL_GN)
Frontrahmen metallisch



RQJSTBL...

IP65

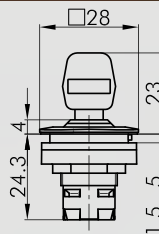

Schlüsseltaste

inkl. zwei Schlüssel
verschiedenschließend möglich, Mehrpreis a. A.
Frontrahmen metallisch

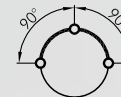

RQJSSA12

IP65

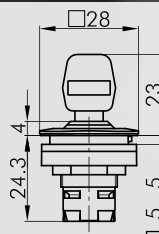

Schlüsseltaste

Frontrahmen metallisch

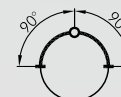

RQJSSA13

IP65

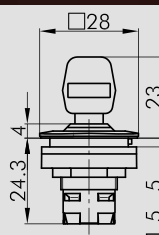

Schlüsseltaste

Frontrahmen metallisch

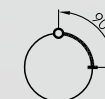

RQJSSA14

IP65

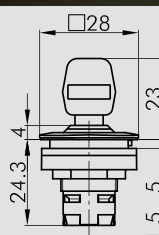

Schlüsseltaste









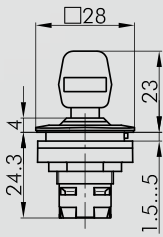

Frontrahmen metallisch

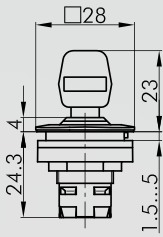
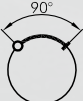

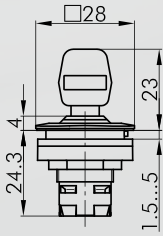
RQJSSA15

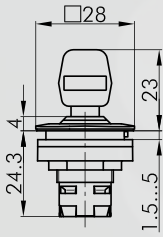
Schlüsseltaste (tastend/schaltend)

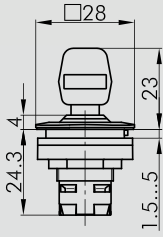
- I = Schaltstellung
- > = Federrückzug
- = Schlüsselabzugstellung

Abbildung	Abmessung	Beschreibung	Type
		<p>Schlüsseltaste Frontrahmen metallisch</p>	 <p>RQJSSA16</p>
		<p>Schlüsseltaste Frontrahmen metallisch</p>	 <p>RQJSSA17</p>
		<p>Schlüsseltaste Frontrahmen metallisch</p>	 <p>RQJSSA18</p>
		<p>Schlüsseltaste Frontrahmen metallisch</p>	 <p>RQJSSA23</p>
		<p>Schlüsseltaste Frontrahmen metallisch</p>	 <p>RQJSSA25</p>

IP65
 Befehlsgeräte
 Berührer
 Freilaufverbindungen
 Galvanis
 Ein-/Auswähler
 Totschlüssel
 Befehlsgeräten

RONTRON-Q-JUWEL

Ø 22 mm

Schlüsseltaste (tastend/schaltend)

- I = Schaltstellung
- > = Federrückzug
- = Schlüsselabzugstellung

Abbildung

Abmessung

Beschreibung

Type

IP65

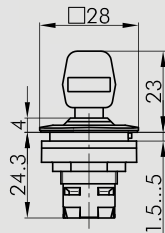

Schlüsseltaste

Frontrahmen

metallisch



RQJSSA28

IP65

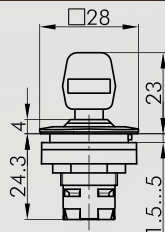

Schlüsseltaste

inkl. drei Schlüssel

1. Schlüssel:

Rechts-Links-Betätigung

2. Schlüssel:

nur Links-Betätigung

3. Schlüssel:

nur Rechts-Betätigung

Frontrahmen

metallisch

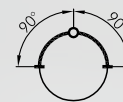

RQJSSA31



Ersatzschlüssel

bitte Schlüsselnr. angeben

ESMIC...

Akustischer Signalgeber

Abbildung

Abmessung

Beschreibung

Type

IP65

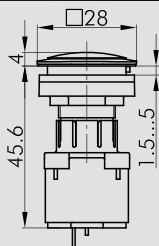

Akustischer Signalgeber

Betriebsspannung: 12 ... 24V AC/DC
 Betriebsstrom: max. 30mA
 Signalfrequenz: 3,5 +/- 0,5 Hz
 Lautstärke: max. 87 db (10cm, 24V)
 max. 85 db (10cm, 12V)
 Betriebstemperatur: -20°C ... 60°C
 Frontrahmen: metallisch

RQJNSG+SG-24V

IP65

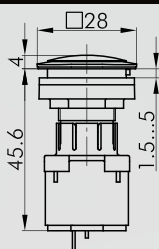

Akustischer Intervall-Signalgeber

Betriebsspannung: 12 ... 24V AC/DC
 Betriebsstrom: max. 30mA
 Signalfrequenz: 3,5 +/- 0,5 Hz
 Lautstärke: max. 87 db (10cm, 24V)
 max. 85 db (10cm, 12V)
 Intervall: 1s
 Betriebstemperatur: -20°C ... 60°C
 Frontrahmen: metallisch

RQJNSG+SGI-24V



Flachsteckhülse 2,8 x 0,8 mm mit Rastzunge

FH2,8

Querschnittsbereich 0,75 - 1,50 mm², Messing, mit Rastzunge zum Einrasten in Anschlussstecker XA, XAL und IH2,8



Isolierstoffhülse

IH2,8

für Flachsteckhülse FH2,8, von vorne aufsteckbar



Flachsteckverteiler

FD2,8

zum Anschließen von 2 Flachsteckhülsen FH2,8 an einer Flachsteckzunge 2,8 x 0,8 mm



Ø 22 mm

Leuchtvorsatz/Meldeleuchten

Tasterkappen/Kalotten und Bezeichnungsschilder bitte extra bestellen

Abbildung

Abmessung

Beschreibung

Type

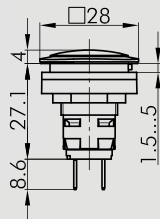

Meldeleuchte mit Flachsteckanschlüssen 2,8x0,8 mm

mit Fassung W2x4,6d

Frontrahmen metallisch

RQJL4

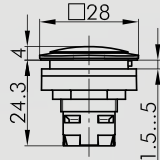

Leuchtvorsatz

Frontrahmen metallisch

RQJN



Kalotte

in den Farben: BL-blau, GB-gelb, GN-grün, KL-glas-klar, RT-rot, WS-opalweiß

Kurzbezeichnung an die Type anhängen, z. B. K22RRRT

K22RR...



Bezeichnungsschild

mit Standarddruck, bitte Index-Nr. angeben (siehe Bezeichnungsschilder)

BSRR...

Bezeichnungsschild

mit Sonderdruck nach Kundenangabe

BSRRB



Bezeichnungsschild unbedruckt

BSRRU

Zubehör Betätiger

Abbildung	Abmessung	Beschreibung	Type
		Montageschlüssel Sechskant mit Drehmomentbegrenzung für die Baureihen OKTRON, OKTRON-JUWEL, OKTRON-R, RONTRON-R-JUWEL, RONTRON-R-Exclusive, RONTRON-Q-JUWEL, RONTRON-Q-Exclusive, QUARTRON(-L), QUARTRON-JUWEL(-L), RX, RX-JUWEL	S16
		Montageschlüssel-Adapter mit 1/4-Zoll-Standardanschluss für S16 und S22	SRA
		Unterlegschild gelb selbstklebende PVC-Folie Bedruckung auf Anfrage Außen-Ø: 75 mm für Einbauöffnung Ø 22 mm Farbe gelb	NAS_22
		Unterlegschild 4-sprachig bedruckt selbstklebende PVC-Folie Außen-Ø: 75 mm für Einbauöffnung Ø 22 mm Farbe gelb	NAS_22_548
 		Schutzkragen gelb für Betätiger mit Einbauöffnung Ø 22 mm Farbe gelb	RXJSK
		Lampenzieher	LZ-MG
		Universal-Kappenabheber	USK

Betätiger
 Befehlsgeräte
 Freilaufverbindungen
 Gehäuse
 Einlötlötter
 Fall- und
 Befehlsgeräten

Zubehör RONTRON-Q-JUWEL

Ø 22 mm

Zubehör Betätiger

Abbildung

Abmessung

Beschreibung

Type

IP65



Blindverschluss

zum Verschließen vorhandener Einbauöffnungen

Frontrahmen

metallisch

BVRQJ

- hohl
- flach
- Betätiger**
- Befehlsgeräte
- Feldschlüsselungen
- Gehäuse
- Kinderschutz
- Leuchte
- Wahlkammer



Interior

Wohnen

Befehlsgeräte
Betreiber

Fachausbildungen

Geometriem

Endschalter

Fußschalter

Bühnenleuchten