



Frontabmessung: Ø 28 mm
Einbauöffnung: Ø 22 mm
Frontrahmenhöhe: 2 mm
Hub: 3 mm



RONTRON-RJ-Edelstahl

Übersicht / Hülsenfarben / Symbolerklärung Baureihe RONTRON-RJ-Edelstahl



01	Drucktasten	Seite 163
02	Einzel-Folien-Tasten	Seite 164
03	Wahltasten	Seite 164
04	Schlüsseltasten	Seite 166
05	Akustische Signalgeber	Seite 168
06	Leuchtenvorsatz / Meldeleuchten	Seite 169



IP65 Schutzart

 beleuchtbar

3mm Betätigungshub

 beschriftbar

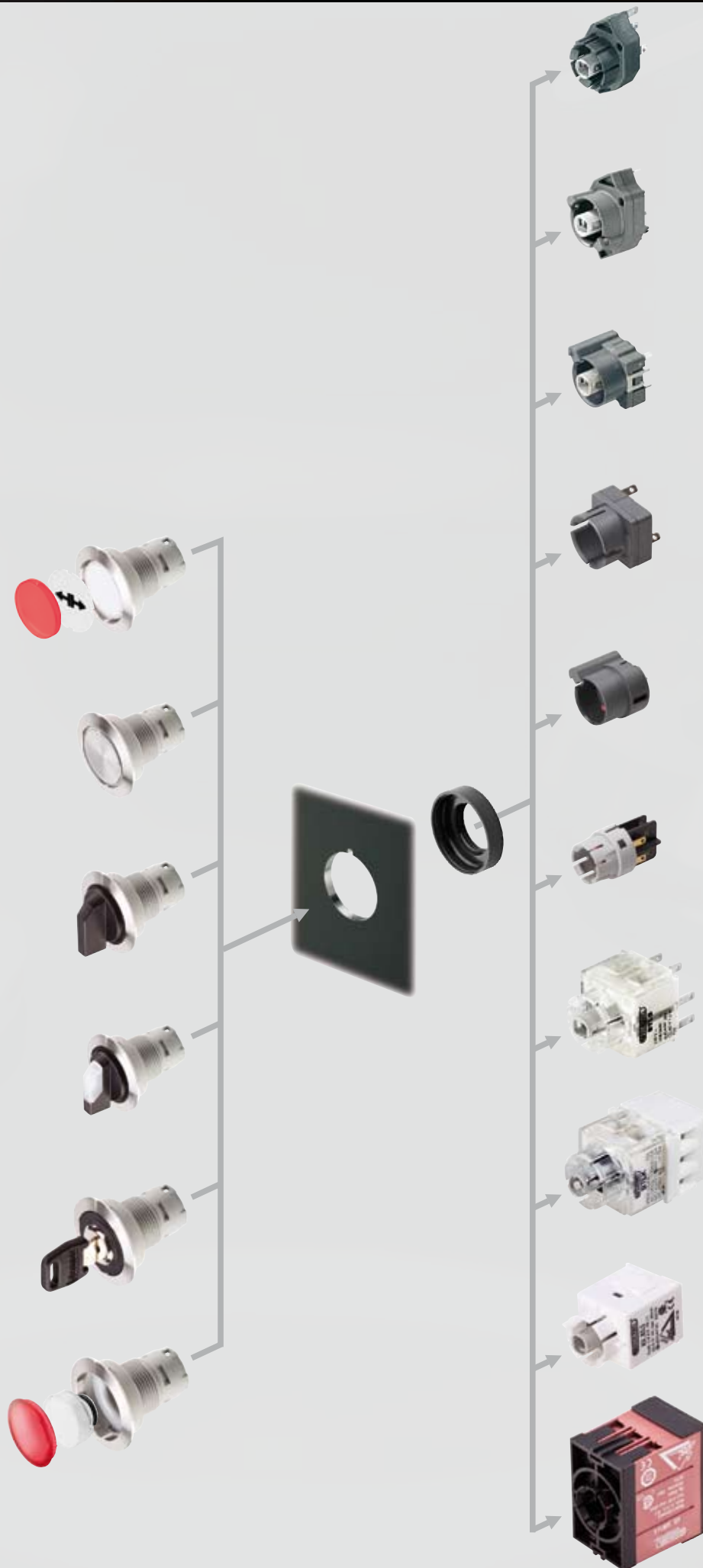

Einbautiefenmaße

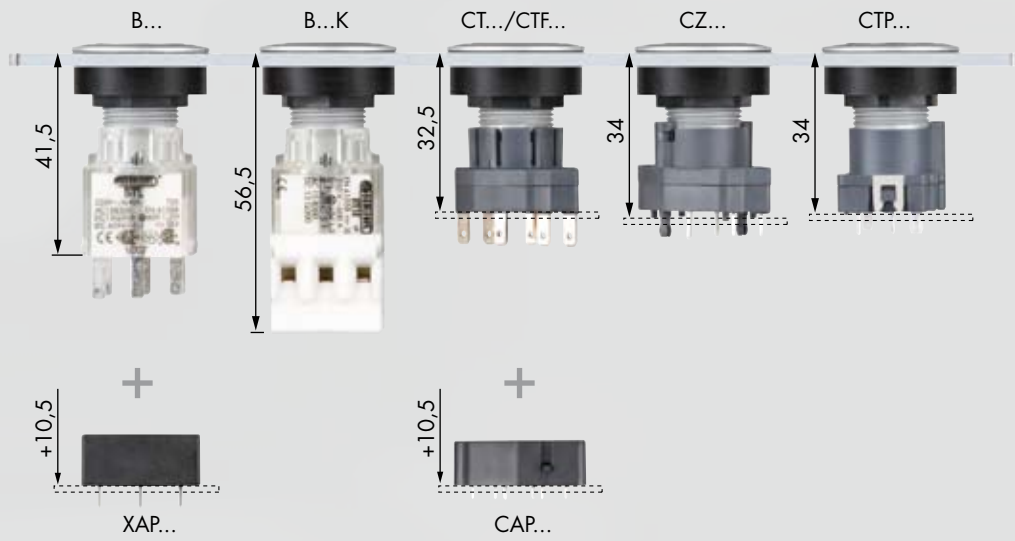

Maße Einbauöffnung

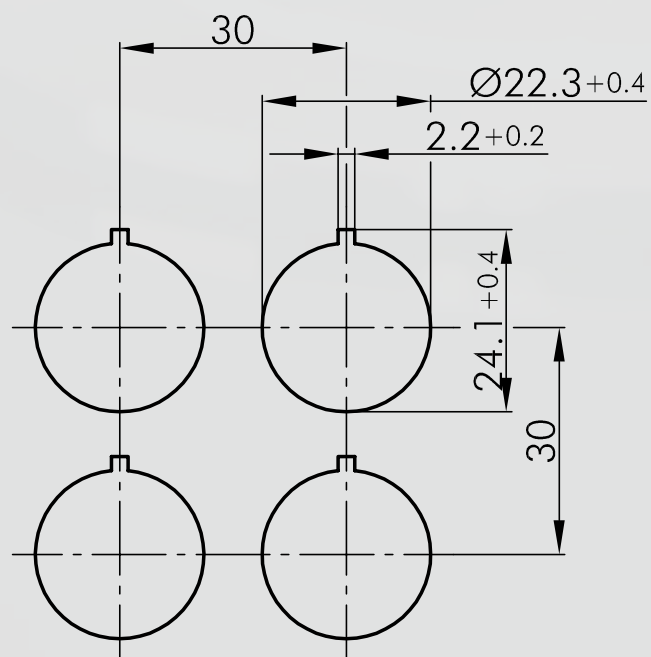

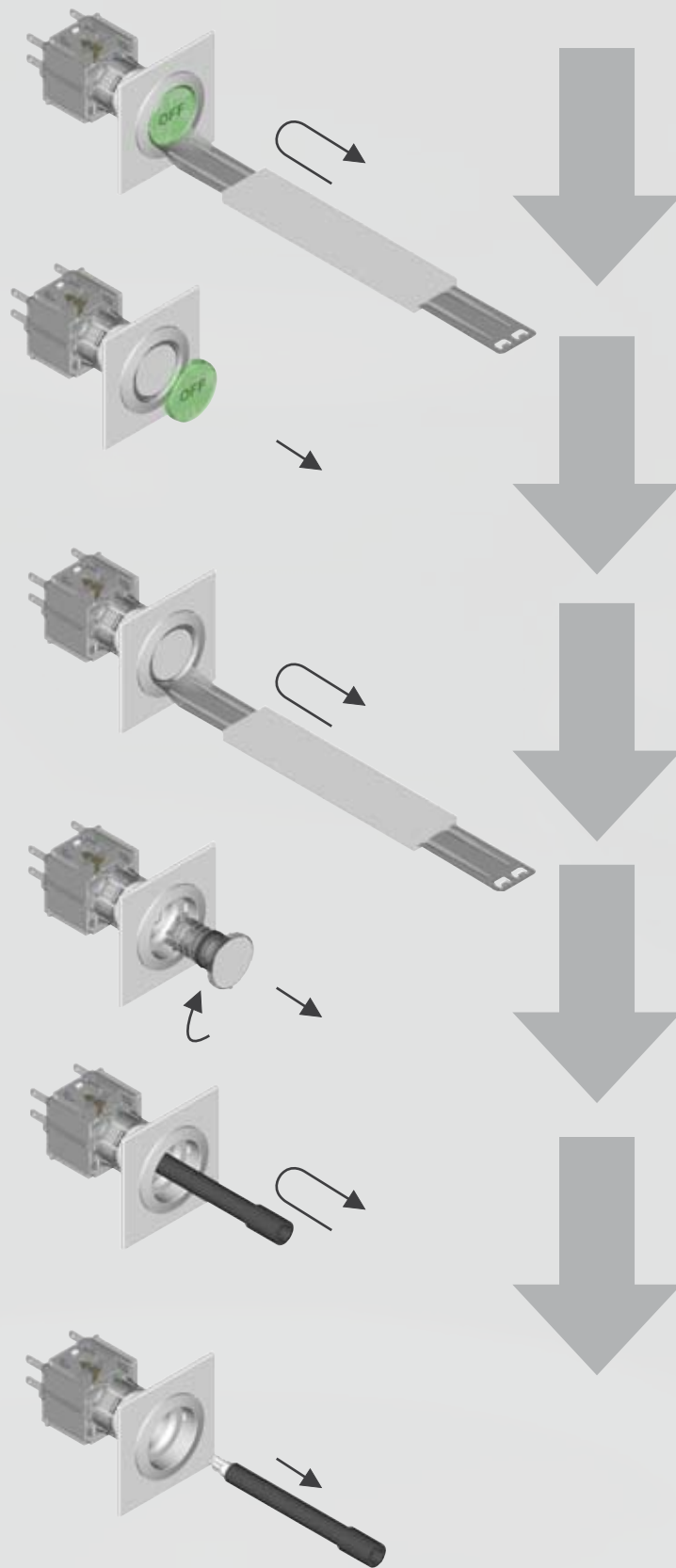







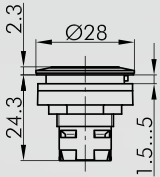

	RRJVAFT	RRJVAN	RRJVASSA12	RRJVASSA13	RRJVASSA14	RRJVASSA15	RRJVASSA16	RRJVASSA17	RRJVASSA18	RRJVASSA23	RRJVASSA25	RRJVASSA28	RRJVASSA31	RRJVASTA	RRJVASTAL...	RRJVASTB	RRJVASTBL...	RRJVAT	RRJVATLR	RRJAWA	RRJAWAL...	RRJAWB	RRJAWBL...	RRJAWC	RRJAWCL...
ASI_BZ			●	●	●	●	●	●	●	●	●	●	●	●				●	●	●		●	●	●	
ASI_BZL5		●													●		●	●				●	●		●
BF(K)																		●							
BFI(K)																		●							
BFL(K)																		●	●						
BFL5(K)																		●	●	●					
BFL5_439																		●	●	●					
BFLI(K)																		●	●	●					
BFLI5(K)																		●	●	●					
BFL_439																		●	●	●					
BF_439																		●							
BL4(K) / BL5(K)		●																							
BT(K)					●	●	●	●	●		●		●					●		●					
BTI(K)					●	●	●	●	●		●		●					●		●					
BTL(K)														●				●	●		●				
BTL5(K)														●				●	●		●				
BTL5_439														●				●	●		●				
BTLI(K)														●				●	●		●				
BTLI5(K)														●				●	●		●				
BTLO(K)														●				●	●		●				
BTLO5(K)														●				●	●		●				
BTL_439														●				●	●		●				
BTO(K)					●	●	●	●	●		●		●					●		●					
BT_439					●	●	●	●	●		●		●					●		●					
BZI(K)					●	●	●	●	●		●		●					●		●					
BZII(K)			●	●	●	●	●	●	●	●	●	●	●	●		●		●		●		●		●	
BZLI(K)														●				●	●		●				
BZLI5(K)														●				●	●		●				
BZLII(K)														●				●	●		●		●		●
BZLII5(K)														●				●	●		●		●		●
BZLO(K)														●				●	●		●				
BZLO5(K)														●				●	●		●				
BZLOI(K)														●				●	●		●		●		●
BZLOI5(K)														●				●	●		●		●		●
BZLOO(K)														●				●	●		●		●		●
BZLOO5(K)														●				●	●		●		●		●
BZL_439														●				●			●		●		●
BZO(K)					●	●	●	●	●	●	●	●	●	●	●			●		●					
BZOI(K)			●	●	●	●	●	●	●	●	●	●	●	●	●	●		●		●		●		●	
BZOO(K)			●	●	●	●	●	●	●	●	●	●	●	●	●	●		●		●		●		●	
BZ_439			●	●						●	●	●	●	●	●	●				●		●		●	
CL		●																							
CLP_485		●																							
CT	●				●	●	●	●	●		●		●					●		●					
CT2	●	●	●	●	●	●	●	●	●	●	●	●	●	●	●	●		●		●		●		●	
CTF	●				●	●	●	●	●		●		●					●		●					
CTL	●													●				●	●		●				
CTL2	●													●				●	●		●		●		●
CTLF	●													●				●	●		●				
CTLP_485	●													●				●	●		●				
CTP_485	●				●	●	●	●	●		●		●					●		●					
CZLP		●																							
CZTLP	●													●				●	●		●				
CZTLP2	●													●				●	●		●		●		●
CZTP	●				●	●	●	●	●		●		●					●		●					
CZTP2	●	●	●	●	●	●	●	●	●	●	●	●	●	●	●	●		●		●		●		●	
L4		●																							

Drucktaste (tastend/schaltend)

Tasterkappen/Kalotten und Bezeichnungsschilder bitte extra bestellen

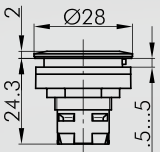
Abbildung	Abmessung	Beschreibung	Type
  	<p>Drucktaste Frontrahmen</p> <p>metallisch</p>	RRJVAT	
	<p>Tasterkappe, flach, transparent Farben: BL-blau, GB-gelb, GN-grün, KL-glasklar, RT-rot, WS-opalweiß Kurzbezeichnung an die Type anhängen, z. B. T22RRBL</p>	T22RR...	
	<p>Tasterkappe, flach, gedeckt Ausführung für unbeschriftete Tasten (nicht beleuchtbar). Farben: BL-blau, GB-gelb, GN-grün, SW-schwarz, RT-rot, WS-weiß Kurzbezeichnung an die Type anhängen, z. B. T22RRGWS</p>	T22RRG...	
	<p>Bezeichnungsschild unbedruckt</p>	BSRRU	
	<p>Bezeichnungsschild mit Standarddruck, bitte Index-Nr. angeben (siehe Bezeichnungsschilder)</p>	BSRR...	
	<p>Bezeichnungsschild mit Sonderdruck nach Kundenangabe</p>	BSRRB	
  	<p>Drucktaste mit Ringbeleuchtung inkl. Tasterkappe, Beschriftung auf Anfrage Frontrahmen</p> <p>metallisch</p>	RRJVATLR	

Ø 22 mm

Folientaster
Potentiometer-Antrieb
Wahltaste (tastend/schaltend)

I = Schaltstellung
 > = Federrückzug

Abbildung

Abmessung

Beschreibung

Type

IP69K

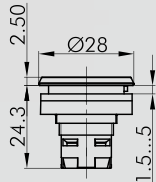

Einzel-Folien-Taste aus Edelstahl V4A



Die Vorteile einer Folientastatur kombiniert mit der Flexibilität von herkömmlichen Betätigern, mit unbedrucktem Bezeichnungsschild.
 Auf Wunsch mit Standarddruck oder Sonderdruck.

Farbe metallisch

RRJVAFT

IP65

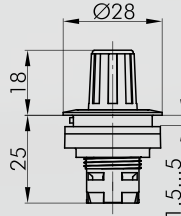

Potentiometer-Antrieb

Mit Drehgriff, jedoch ohne Poti. Für Poti mit 6 mm Achsendurchmesser und Gewinde M10 x 0,75.
 Achsenlänge: ca. 32 mm

Frontrahmen metallisch

RRJVAR

IP65

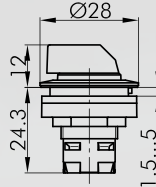

Wahltaste

Frontrahmen metallisch



RRJVAWA

IP65

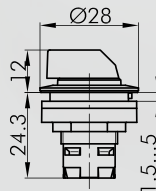

Wahltaste

Frontrahmen metallisch



RRJVAWB

IP65

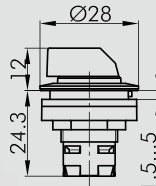

Wahltaste

Frontrahmen metallisch



RRJVAWC

IP65

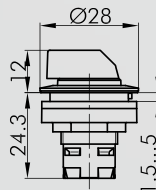

Schwenktaste



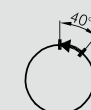







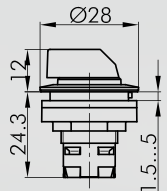

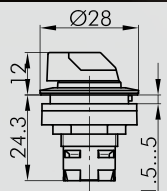
Frontrahmen metallisch

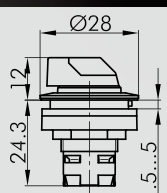

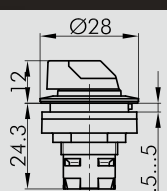
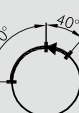
RRJVASTA

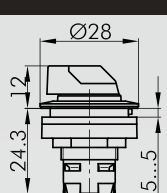
Wahltaste (tastend/schaltend)

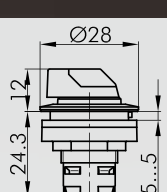
I = Schaltstellung
> = Federrückzug

Abbildung	Abmessung	Beschreibung	Type
<p>IP65</p> 		<p>Schwenktaste Frontrahmen metallisch</p>	 <p>RRJVASTB</p>
<p>IP65</p> 		<p>Leucht-Wahltaste Knebefarben: BL-blau, GB-gelb, KL-glasklar, GN-grün, RT-rot (z.B. RRJVAWAL_GN) Frontrahmen metallisch</p>	 <p>RRJVAWAL...</p>
<p>IP65</p> 		<p>Leucht-Wahltaste Knebefarben: BL-blau, GB-gelb, KL-glasklar, GN-grün, RT-rot (z.B. RRJVAWBL_GN) Frontrahmen metallisch</p>	 <p>RRJVAWBL...</p>
<p>IP65</p> 		<p>Leucht-Wahltaste Knebefarben: BL-blau, GB-gelb, KL-glasklar, GN-grün, RT-rot (z.B. RRJVAWCL_GN) Frontrahmen metallisch</p>	 <p>RRJVAWCL...</p>
<p>IP65</p> 		<p>Leucht-Schwenktaste Knebefarben: BL-blau, GB-gelb, KL-glasklar, GN-grün, RT-rot (z.B. RRJVASTAL_GN) Frontrahmen metallisch</p>	 <p>RRJVASTAL...</p>
<p>IP65</p> 		<p>Leucht-Schwenktaste Knebefarben: BL-blau, GB-gelb, KL-glasklar, GN-grün, RT-rot (z.B. RRJVASTBL_GN) Frontrahmen metallisch</p>	 <p>RRJVASTBL...</p>

Produkttypen
 Befehlsgeräte
 Berührer
 Feldbusverbindungen
 Gehäuse
 Entschalter
 Fall- und
 Rollschleusen

RONTRON-RJ-Edelstahl

Ø 22 mm

Schlüsseltaste (tastend/schaltend)

- I = Schaltstellung
- > = Federrückzug
- = Schlüsselabzugstellung

Abbildung

Abmessung

Beschreibung

Type

IP65

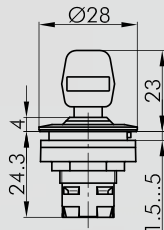

Schlüsseltaste

inkl. zwei Schlüssel
verschiedenschließend möglich, Mehrpreis a. A.
Frontrahmen metallisch

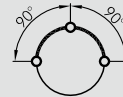

RRJVASSA12

IP65

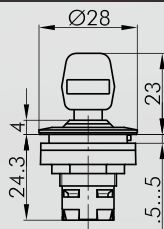

Schlüsseltaste

inkl. zwei Schlüssel
verschiedenschließend möglich, Mehrpreis a. A.
Frontrahmen metallisch

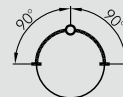

RRJVASSA13

IP65

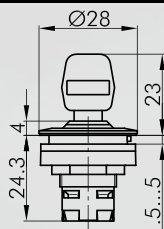

Schlüsseltaste

inkl. zwei Schlüssel
verschiedenschließend möglich, Mehrpreis a. A.
Frontrahmen metallisch



RRJVASSA14

IP65

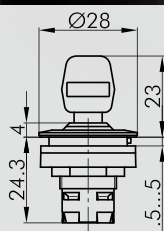

Schlüsseltaste

inkl. zwei Schlüssel
verschiedenschließend möglich, Mehrpreis a. A.
Frontrahmen metallisch



RRJVASSA15

IP65

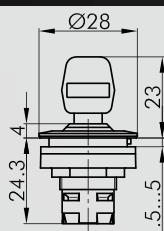

Schlüsseltaste

inkl. zwei Schlüssel
verschiedenschließend möglich, Mehrpreis a. A.
Frontrahmen metallisch



RRJVASSA16

Schlüsseltaste (tastend/schaltend)

- I = Schaltstellung
- > = Federrückzug
- = Schlüsselabzugstellung

Abbildung

Abmessung

Beschreibung

Type

IP65

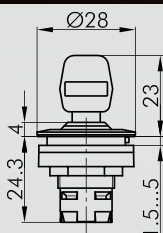

Schlüsseltaste

inkl. zwei Schlüssel
verschiedenschließend möglich, Mehrpreis a. A.
Frontrahmen metallisch



RRJVASSA17

IP65

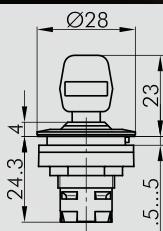

Schlüsseltaste

inkl. zwei Schlüssel
verschiedenschließend möglich, Mehrpreis a. A.
Frontrahmen metallisch



RRJVASSA18

IP65

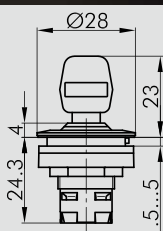

Schlüsseltaste

inkl. zwei Schlüssel
verschiedenschließend möglich, Mehrpreis a. A.
Frontrahmen metallisch



RRJVASSA23

IP65

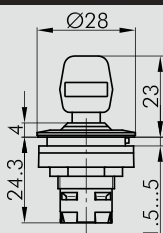

Schlüsseltaste

inkl. zwei Schlüssel
verschiedenschließend möglich, Mehrpreis a. A.
Frontrahmen metallisch



RRJVASSA25

IP65

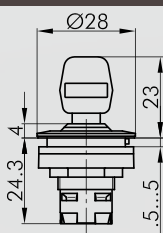

Schlüsseltaste

inkl. zwei Schlüssel
verschiedenschließend möglich, Mehrpreis a. A.
Frontrahmen metallisch



RRJVASSA28



Ø 22 mm

Schlüsseltaste (tastend/schaltend)
Akustischer Signalgeber

I = Schaltstellung
> = Federrückzug
○ = Schlüsselabzugstellung

Abbildung

Abmessung

Beschreibung

Type

IP65

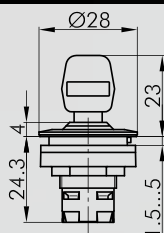

Schlüsseltaste

inkl. drei Schlüssel

- 1. Schlüssel: Rechts-Links-Betätigung
 - 2. Schlüssel: nur Links-Betätigung
 - 3. Schlüssel: nur Rechts-Betätigung
- Frontrahmen metallisch

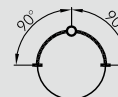

RRJVASSA31

IP65

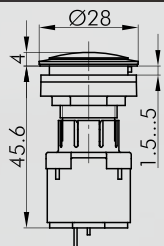

Akustischer Signalgeber

Betriebsspannung: 12 ... 24V AC/DC
 Betriebsstrom: max. 30mA
 Signalfrequenz: 3,5 +/- 0,5 kHz
 Lautstärke: max. 87 db (10cm, 24V)
 max. 85 db (10cm, 12V)
 Betriebstemperatur: -20°C ... 60°C
 Frontrahmen metallisch

RRJVANSG+SG-24V

IP65

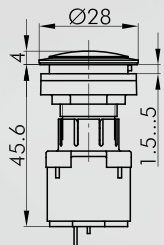







Akustischer Intervall-Signalgeber

Betriebsspannung: 12 ... 24V AC/DC
 Betriebsstrom: max. 30mA
 Signalfrequenz: 3,5 +/- 0,5 kHz
 Lautstärke: max. 87 db (10cm, 24V)
 max. 85 db (10cm, 12V)
 Intervall: 1s
 Betriebstemperatur: -20°C ... 60°C
 Frontrahmen metallisch

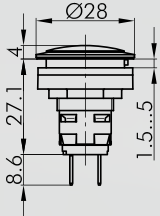
RRJVANSG+SIGI-24V

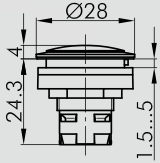
Leuchtvorsatz/Meldeleuchten

Tasterkappen/Kalotten und Bezeichnungsschilder bitte extra bestellen

Abbildung	Abmessung	Beschreibung	Type
		<p>Meldeleuchte mit Flachsteckanschlüssen 2,8x0,8 mm mit Fassung W2x4,6d Frontrahmen metallisch</p>	RRJVAL4
		<p>Leuchtvorsatz Frontrahmen metallisch</p>	RRJVAN
		<p>Kalotte in den Farben: BL-blau, GB-gelb, GN-grün, KL-glas-klar, RT-rot, WS-opalweiß Kurzbezeichnung an die Type anhängen, z. B. K22RRRT</p>	K22RR...
		<p>Bezeichnungsschild unbedruckt</p>	BSRRU
		<p>Bezeichnungsschild mit Standarddruck, bitte Index-Nr. angeben (siehe Bezeichnungsschilder)</p>	BSRR...
		<p>Bezeichnungsschild mit Sonderdruck nach Kundenangabe</p>	BSRRB

IP65
 Metall
 Befehlsgeräte
 Betrüger
 Feldbusverbindungen
 Gehäuse
 Entschalter
 Frühwarn-
 Rückmeldung

Zubehör Betätiger

Abbildung	Abmessung	Beschreibung	Type
-----------	-----------	--------------	------



Montageschlüssel

S16

Sechskant mit Drehmomentbegrenzung für die Baureihen OKTRON, OKTRON-JUWEL, OKTRON-R, RONTRON-R-JUWEL, RONTRON-R-Exclusive, RONTRON-Q-JUWEL, RONTRON-Q-Exclusive, QUARTRON(-L), QUARTRON-JUWEL(-L), RX, RX-JUWEL



Montageschlüssel-Adapter mit 1/4-Zoll-Standardanschluss
für S16 und S22

SRA



Außenbezeichnungsträger

für selbstklebende Bezeichnungsschilder zur Beschriftung außerhalb der Betätiger passend für RONTRON-R-JUWEL. Von vorne aufrastbar.

Farbe transparent

RRJABT

selbstklebendes Bezeichnungsschild gelasert

BZ16G

beschriftet nach Kundenangabe
Maße: 22 x 11 mm

selbstklebendes Bezeichnungsschild leer

BZ16U

Maße: 22 x 11 mm



selbstklebendes Bezeichnungsschild

BZ16B...

mit Standarddruck, bitte Index-Nr. angeben (siehe Bezeichnungsschilder)
Maße: 22 x 11 mm







Schutzklappe von vorne aufrastbar

Farbe transparent

KD22RR

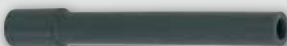
Zubehör Betätiger

Abbildung	Abmessung	Beschreibung	Type
		plombierbare Schutzklappe Farbe transparent	KDP22RR
	IP67	Schutzklappe aus TPE Farbe weiß	AK22RR
		Lampenzieher	LZ-MG
		Universal-Kappenabheber	USK

- Betätiger
- Befehlsgeräte
- Freidrahtverbindungen
- Gehäuse
- Einfachhalter
- Früh-Fahrer
- Rollelemente